

OCTOBER

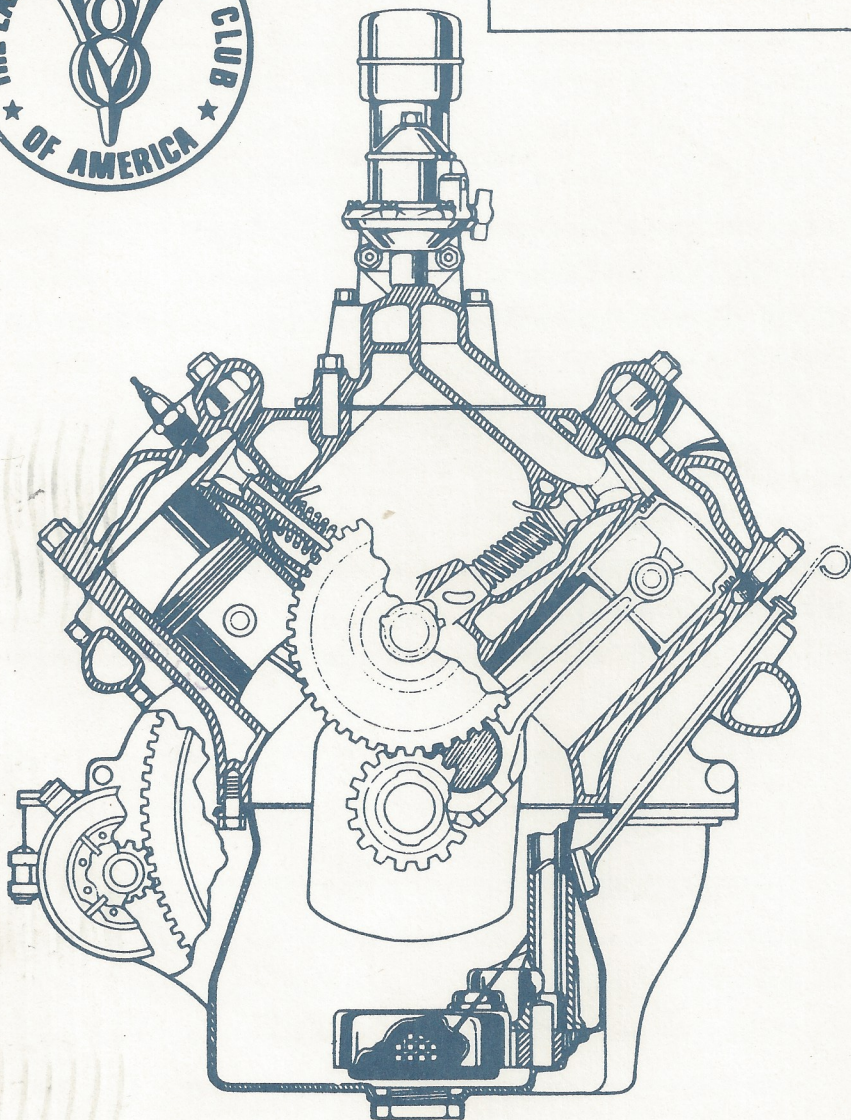

*Drive Lines*

# *The Valley* 's

---

## 1987 OFFICERS

PRESIDENT, JOHN KEMMERER .....	843-2138
VICE PRESIDENT, PAT BERRY .....	848-5466
SECRETARY, JULIE BLACKWELL.....	(805) 499-1021
TREASURER, LARRY CAPLAN.....	363-2849
ACTIVITIES CHAIRMAN, DOUG PETERSON .....	703-0738
DIRECTOR, HISTORIAN, RUSS SYLVIS .....	(805) 527-4387
ACCESSORIES, ERNIE BAILY .....	(805) 522-9674
MEMBERSHIP, TERRY SMITH.....	989-3119
FELLOWSHIP, REFRESHMENTS, VIRGINIA WOLF .....	789-6201
EDITOR, CHUCK MAIR .....	785-9413
INFORMATION OFFICER, BOB McCULLAGH.....	886-2644

---

## *Drive Lines*

Published by

SAN FERNANDO VALLEY CHAPTER 40  
of the EARLY FORD V8 CLUB of AMERICA

P.O. Box 96  
RESEDA, CA. 91335

COVER/ROY JONES

Valley V-8s  
October 1987

As our current year winds down, Kent Lowry, as head of our nominating committee, has been busy putting together a slate of officers for next year. Several members have expressed a desire to seek a particular office, while others are reluctant to hold an office because they don't have the experience or the time. As far as experience goes, the only experience necessary is the experience of commitment and desire; Commitment to accept the responsibility of the office and a desire to see the club continue and succeed. Please let Kent, Paul Kirk or Ed Warnock know if you are interested in seeking an office. Ballots will be included with the November newsletter and collected at our November meeting.

Can you believe that we are finally going to have a meeting back at our regular meeting site (Mercury Savings - Magnolia & Laurel Canyon) on October 4th? It will be good to see all the regular members together again. Dave Sanborn has an exciting evening planned with slides and commentary from the Bend tour. Pat Berry will be assisting Dave and hopes to have a video tape of the Bend meet. Also Russ Sylvis plans to have our largest raffle

ever, since he has been collecting prizes from our sponsors all summer and will be giving them away on the 4th. So, bring your check-books, we have to make up for two months without a raffle.

Pizza night was a huge success thanks to the efforts of John and Bonnie Busk, and participation from many of our members. There were about forty-five entries with Bruce Blackwell taking a third place trophy, for his '36 Roadster. — See Julie Blackwell's article for more details on Pizza night, since I, once again, had to be back East and could not attend.

Upcoming tours and events include the All Ford picnic sponsored by the Southern California regional group on October 4th at La Palma Park. Since many of our members want to get there early to enter their cars in the judging, we will not have a guided tour to the park. — By the way, the Southern California Regional Group's bid to host the '89 Western has been accepted by the National Organization. The '89 Western National Meet will be held at Lake Arrowhead during the week of June 14, 1989. There will only be one meet held in 1988 — every five years The National meet is held in Dearborn and is the only national meet

held that year. The 1988 Dearborn meet will be held August 8 through the 13, 1988.

On October 31, The Valley V-8s will be joining the Ventura V-8s for the annual Oso Flaco tour. (See flyer in newsletter). Then on November 8th we will gather for our annual four club brunch tour, coordinated by Dave Sanborn.

Finally to conclude our November activities (three tours in three weeks - we didn't plan it that way folks), November 14th is the date for our Merle Norman - San Sylmar tour.

Because of the interest in this tour and the limited number of tickets available from the museum, participation will be limited to members with tickets only. So get your reservation in with Gerry Blackwell Now!

The Board of Directors met, on August 29th, with a good turnout of officers and past presidents. Agenda items covered at the meeting were plans for our installation dinner, coordinated by Al and Ruth Spencer, Club officers for 1988, club activities - should we concentrate on <sup>tours, monthly meetings, technical info, or social</sup> ~~our~~ activities? It was agreed that, since the club is made up of many different persons with different needs and interests, we should endeavor to meet all our members interests with a balance of all of the above activities. One thing we do need is

feedback from all of the members, let us know what you think and what we can do for you in the way of activities. Another important item discussed at the board meeting was the status of the club treasury. Although our club Treasury is currently in a strong position (Thanks to the income from Ventura Ventures) our expenditures during the past two years have exceeded our income.— Did you know the income from membership dues only covers approximately two-thirds of our printing and postage costs. — Anyhow, with the exception of the Installation Dinner our future activities will have to be self supporting and we all are going to have to pitch in and support our fund raising activities, such as the annual auction, better than we have been doing during the past several years. — Enough said!

— Has anyone seen our club banner? If you know where it is — or even if you think you know where it is — let me know. In the meantime check your closets, cars, garages and other places to see if you have it.

See you at the meeting on October 4th. Until that time, enjoy your Ford and your Ford Club.

  
John Kemmerer

**- Valley V-8's Monthly Meeting**  
**7:00 p.m. Mercury Savings**  
**5201 Laurel Canyon Blvd.**  
**Studio City, CA**

---

- October 4 - All Ford Picnic La Palma Park
- October 31 - Oso Flaco - Annual Tour
- November 8 - Dave Sanborn's Quad Club's  
Brunch
- November 14 - Merle Norman - San Sylmar Tour
- December 4 - Installation Dinner and  
Christmas party - Al and Ruth  
Spencer



Thanks to Gerry Blackwell for coordinating  
our tours and events. - Contact Gerry for  
details on any of the events.

# all FORD picnic

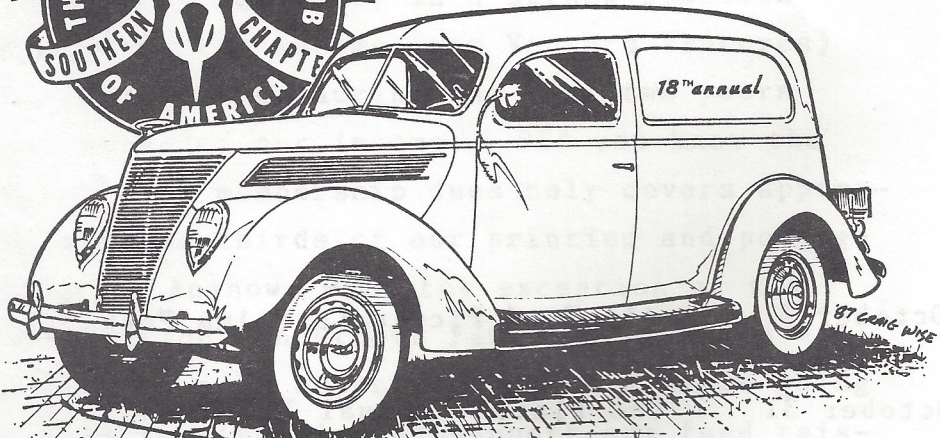

**OCT. 4, 1987**

*La palma park - anaheim, ca*

\$7.00 PER CAR SHOW  
REGISTRATION —  
INCLUDES DASH PLAQUE

9 A.M. - 3 P.M.

**RAFFLES — PRIZES**

**TROPHIES**  
(Increased Classes)

- HOT DOGS
- SOFT DRINKS

**SPECTATORS FREE**

For More Information:  
JOE SCANLIN -213-438-4292

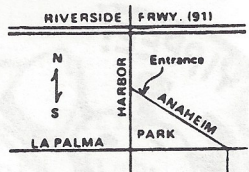



**SATURDAY**

OCTOBER 31, 1987  
(ARRIVE 9:00 A.M.)  
DEPART SANTINO'S PIZZA  
PARKING LOT  
VENTURA & MAIN - VENTURA  
AT 9:30 A.M. SHARP  
TOUR TO LOMPOC FOR LUNCH  
AND THRU CASMALIA  
TO SANTA MARIA



**MOTEL:**  
BEST WESTERN  
BIG AMERICA  
1725 NO. BROADWAY  
SANTA MARIA, CA  
(805) 922-5200  
CALL & MAKE RESERVATIONS  
SINGLE = \$39.00  
DOUBLE = \$42.00  
REFER TO OSO FLACO RUN

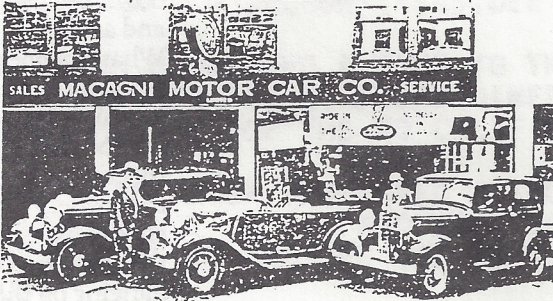

LEAVE MOTEL AT 3:30 P.M.  
FOR JOURNEY TO  
MACAGNI'S OSO FLACO DAIRY  
FOR CARS, CAR PARTS & WINE

DEPART OSO FLACO AT 5:30 P.M. FOR  
FAR WESTERN TAVERN  
FOR THE FAMOUS BULLSEYE STEAK

RETURN TO MOTEL FOR HOSPITALITY

INFO:  
JIM BRITAIN, TOUR DIRECTOR  
(805) 482-5417

**SUNDAY**  
NOVEMBER 1, 1987  
LEAVE BEST WESTERN  
AT 10:00 A.M.  
TOUR TO NOJOQUI FALLS PARK  
TO JOIN CENTRAL COAST  
ST. RODS  
FOR FOOD, DRINK, DASH  
PLAQUES AND FUN

AFTER LUNCH???

JOURNEY HOME

15<sup>TH</sup> ANNUAL  
PRE - PRE 1

RUN TO THE FALLS  
NOJOQUI FALLS - SOLVING CA.

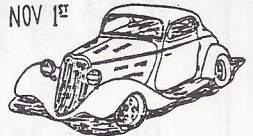

- CENTRAL COAST STREET RODS -

PRE 48 DASH PLAQUES  
FOOD, DRINKS, AJAROS  
30 / 50 DRAWINGS



## Make Something Happen

You come out of a meeting and someone asks, "What happened?"

And you answer, "Nothing."

You sit in a legislative gallery and someone sits down beside you and asks, "What's happening?"

And you say, "Nothing."

Maybe that meeting room and that gallery should have had the same sign hanging on their walls that—

so the story goes—a college football coach pasted in his teams' lockers: "*Cause something to happen.*"

He believed that if you didn't *make* something happen with a good block, your runner would go nowhere—and if you didn't tackle, the other team would run all over you.

He sure caused something to happen. He won more college games than any other coach. Bear Bryant.

For More Information:  
JOE SCANLIN 313-438-4222

## VALLEY V8s HISTORY.....ED WARNOCK

### 1973 A GOOD YEAR

THIS YEAR BEGAN WITH A GROUP OF DEDICATED OFFICERS, MOST OF WHOM HAD BEEN ELECTED IN MID 72 AND HAD AGGREGED TO CONTINUE IN OFFICE. PRES. DOUG PETERSON-DIRECTOR GORDON CHAMBERLIN-VICE PRES, ED WARNOCK-EDITOR BOB WILSON-SEC. LARRY STOCKER-HISTORIAN HAROLD SELSON-TREAS. DEE PETERSON.

CHICK LATCH ORGANIZED A TOUR TO THE QUEEN MARY IN FEB AND THE CLUB WAS JOINED IN THIS EVENT BY MEMBERS OF THE SO CALIF CHAPTER.

THE SO CALIF GROUP SPONSORED A TOUR OF THE RIDGE ROUTE IN MAY AND WERE JOINED BY THE VALLEY V8 AND THE VALLEY MODEL T CLUB.

BUSINESS COMMITMENTS COMPELLED LARRY STOCKER TO RESIGN AS SEC AND HE WAS REPLACED BY JIM ROWE WHO WAS AGAIN ABLE TO GIVE MORE TIME TO CLUB ACTIVITIES. THE MEMBERS PARTICIPATED IN THE MEETINGS AND IN CONTRIBUTIONS TO THE NEWSLETTER.

THE YEAR MODELS FROM 1932 THROUGH 1940 WERE WELL COVERED BY MEMBER PRESENTATIONS AT VARIOUS MEETINGS..

AT THE APRIL MEETING IT WAS UNANIMOUSLY AGGREGED TO JOIN THE ASSOCIATION OF CALIF CAR CLUBS AND EVERYONE PAID ONE DOLLAR DUES.

THE BIG EVENT OF THE YEAR WAS THE GRAND NATIONAL MEET AT DEARBORN, MICH CELEBRATING THE 10TH BIRTHDAY OF THE EARLY FORD V8 CLUB. THE VALLEY V8s WERE WELL REPRESENTED AT THIS MEET BY BOB WILSON, GORDON CHAMBERLIN, SHELL HARRIMAN, DON DURKEE, AND ED WARNOCK.

THE CLUB VISITED A MEETING OF THE FORTIES LIMITED EARLY IN THE FALL. SOME OF THE FORMAT AND ACTIVITIES WE ENJOY TODAY WERE COPIED FROM THEIR FINE GROUP...

THE CLUBS FIRST PICNIC GET TOGETHER WAS ENJOYED AT THE HOME OF PAUL AND LIZ MESKE.

BOB WILSON EDITED AN EXCELLENT NEWSLETTER DURING HIS TERM BUT PERSONAL AND CHURCH COMMITMENTS COMPELLED HIM TO RESIGN HIS OFFICE IN THE FALL. HIS CONTRIBUTIONS HAVE BEEN MISSED. PAUL MESKE TOOK UP THE PEN AS EDITOR AND CONTINUED AN EXCELLENT NEWSLETTER.

THE YEAR WAS HIGHLIGHTED WITH A CHRISTMAS PARTY AT SADDLE PEAK LODGE WITH THIRTY-THREE IN ATTENDANCE. AMONG THE NEW MEMBERS JOINING THIS YEAR WERE PHIL AND MARLENE NORDBERG-BOB AND RICK MURPHY-BILL LASH WAYNE BIGLOW.

THE VALLET V8S COMPLETED THE YEAR WITH 35 MEMBERS AND \$118.64 IN THE BANK.....

.....ED WARNOCK

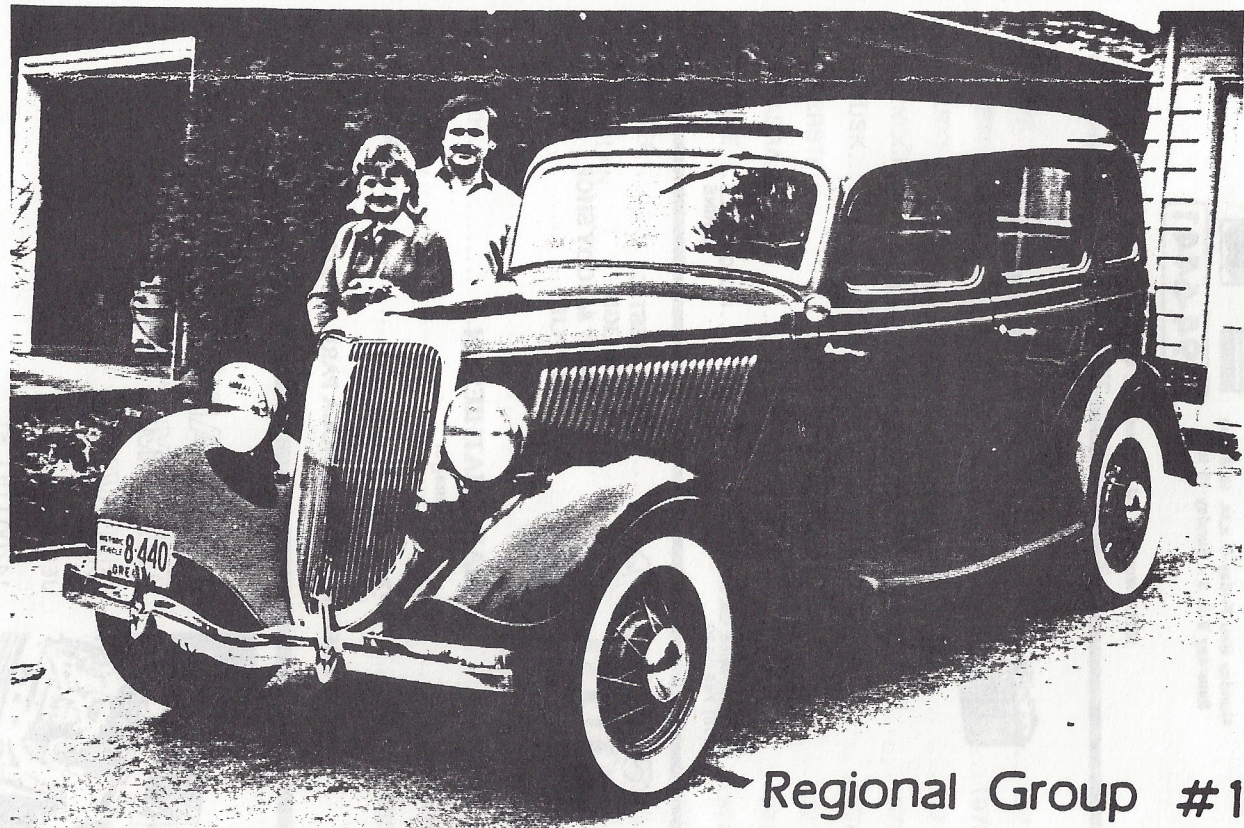

Regional Group #18

**JOY & MARK VINSON WITH THEIR 34**

# DON'S Auto Parts

MACHINE SHOP and BALANCING

Monday thru Friday 9 a.m. to 6 p.m.

Saturday 9 to 6 - Sunday 10 to 4

Domestic &

Foreign

Parts & Supplies



**894-6441**

10241 Woodley (At Devonshire), Sepulveda



NEW &  
RECONDITIONED

## NO. HOLLYWOOD BATTERY

HIGHEST QUALITY FOR MAXIMUM  
PERFORMANCE & LONG LIFE

Correct 6 Volt Sizes  
For Early V-8's

10748 Burbank Blvd.  
No. Hollywood, Ca. 91601  
(818) 766-5530

AUTO  
TRUCK  
MOTORCYCLE  
MARINE

## CANOGA AUTO PARTS

*Serving You Since 1955*

- DOMESTIC
- FOREIGN
- PAINT & BODY SHOP  
SUPPLIES

**RICHARD MATHIESEN**

Manager

**340-1536**

21422 SHERMAN WAY, CANOGA PARK, CA 91303

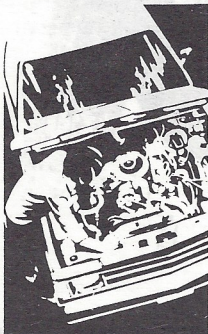

## PRO-CARE AUTOMOTIVE SERVICE

JERRY ALLEN

14700 LULL ST.  
VAN NUYS, CA 91405  
(818) 908-1413

PROFESSIONAL REPAIRS & PREVENTATIVE MAINTENANCE, ON ALL  
MAKES OF CARS & TRUCKS

## PAST PRESIDENT

JIM ROWE.....	1971-72
DOUG PETERSON.....	1972-73
DON DURKEE.....	1974
ED WARNOCK.....	1975
JOHN BUSK.....	1976
CHIP WERSTEIN.....	1977
STAN MASRAJE.....	1978
BOB DRAKE.....	1979
BILL CULP.....	1979
AL SPENCER.....	1980
LARRY CAPLAN.....	1981
BOB ROSE.....	1982
DON DURKEE.....	1983
PAUL KIRK.....	1984
KENT LOWRY.....	1985
DAVE SANBORN.....	1986

# The Valley 's

P.O. BOX 96 - RESEDA, CA 91335

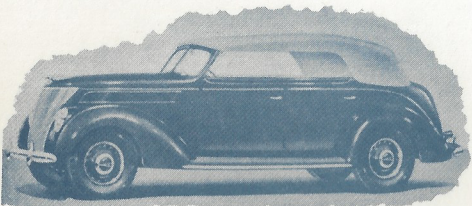
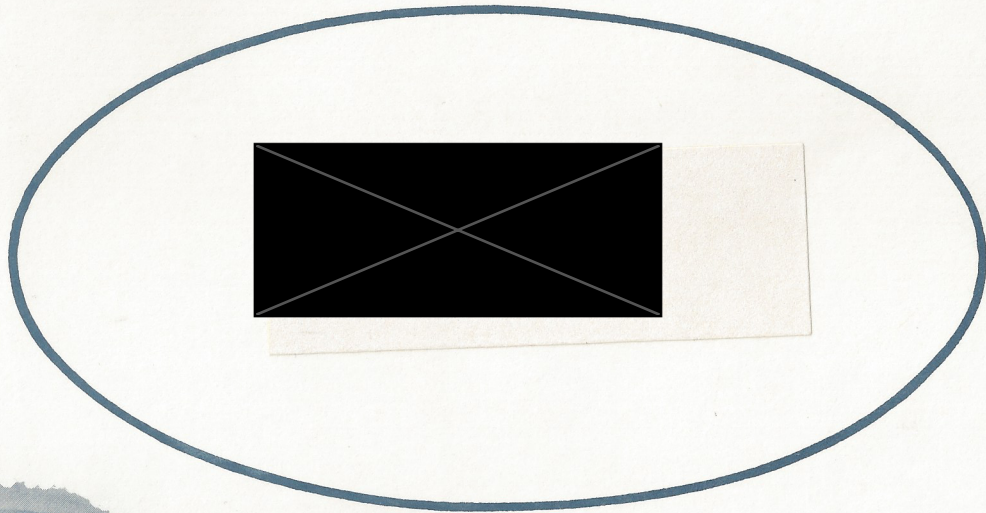
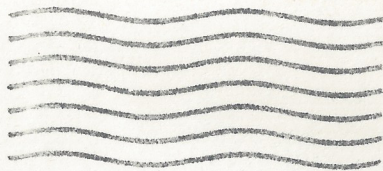

## 50th Anniversary