

MARCH

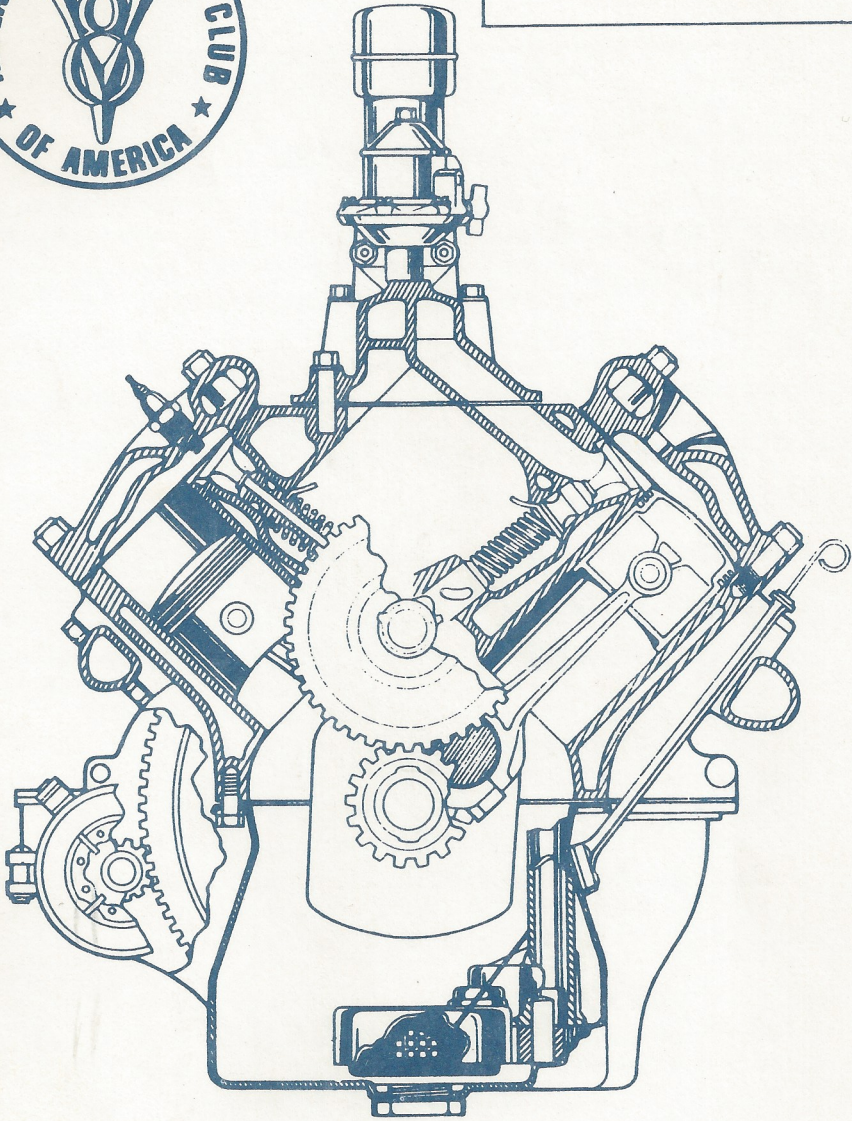

Drive Lines

The Valley 's

1990 OFFICERS

PRESIDENT, JERRY JENSEN.....	(818) 886-5711
VICE PRESIDENT, CHUCK SHUBB.....	(818) 882-2927
SECRETARY, JOHN KEMMERER.....	(818) 843-2138
TREASURER, DON DUPREE.....	(818) 894-7255
HISTORIAN DIRECTOR, BEN DiFATTA.....	(818) 347-9305
ACCESSORIES, JACK MILES.....	(818) 347-8617
MEMBERSHIP, TERRY SMITH.....	(818) 989-3119
FELLOWSHIP/REFRESHMENTS, VIRGINIA WOLF.....	(818) 789-6201
EDITOR, CHUCK MAIR.....	(818) 785-9413 / 786-5008

Drive Lines

Published by

SAN FERNANDO VALLEY CHAPTER 40
of the EARLY FORD V8 CLUB OF AMERICA

P.O. Box 96
Reseda, CA 91335

COVER/ROY JONES

THE VALLEY V-8's

March 1990

PRESIDENT'S MESSAGE

Through the years the weather for The Valley V-8's tours has generally been good. Sunday February 11, the day of our tour to the Museum of Flying, the day couldn't have been nicer. At 9:30 thirteen cars pulled out of the parking lot at Balboa Park and headed for Santa Monica under sunny skies. The Model T Club had chosen to visit the museum the same day, so there was a large variety of cars in the parking lot at the museum. The Museum of Flying has a broad spectrum of exhibits and proved to be very interesting. I for one did not get to see all of it in the one hour forty five minutes we spent there. I plan on going back to see it again. A number of our members enjoyed a delicious brunch at the Acapulco Restaurant, before heading home.

Elsewhere in this issue is an outline of the August tour to the Western National Meet at Reno, lead by Jay Harris of the Southern California Regional Group. Jay has organized and lead many tours to National Meets, and always has a well attended outing. If you plan on joining this tour, take Jay's advice and get your reservations in early for your lodging.

Chuck Shubb is organizing a tour on May 19th to the Queen Mary, Voyage to 1939. This will be a joint tour with the Ventura, Southern California and the Baldy View Chapters. It should be great fun, mark your calendar and save May 19th for a super tour.

Dudley Ochsner is still working on the tour to the Pasadena Historical Society. This will probably take place in June. Details will be published at a later date. We are still looking for ideas for future tours and folks to organize them.

If you are planning on attending the Fabulous Fords Forever Car Show at Knott's Berry Farm on April 29th with your car, you must be preregistered. For more information call 818/343-2091 or write Johna Pepper, 24142 Roma Drive, Mission Viejo, CA 92691 for a registration form.

Club dues are still due if you haven't paid them for 1990. We will soon be working on the 1990 Membership Directory, only paid up members will be included. A note to our advertisers - some of you are due for renewal for 1990. Rates are the same as last year.

The program for the March meeting will be another Lorin Sorensen video. This tape features the Ford Tri-motor, the 1934 Pike's Peak Race, introduction of the 1936 Lincoln Zephr and other subjects. See you at the March meeting.

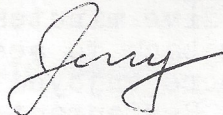

WELCOME TO THE NEW MEMBERS

Ed and Marge Buckner

Kenneth and Joan Sapper

Richard and Judy Chutuk

TOUR TO RENO

Only five months now until we head north to attend RENO IN NINE OH, the Western National Meet in Reno, Nevada. The meet dates are August 6 - 10, 1990 at the Peppermill.

The following is a proposed itinerary for the Harris tour to Reno:

FIRST DAY - THURSDAY, AUGUST 2: The tour will assemble at the Holiday Inn in Buena Park, located on Beach Blvd just north of the 91 (Riverside) freeway. There is a nice restaurant there for those who wish to enjoy breakfast before we depart at 8:00 am. The tour will proceed north on I-5 to the Santa Monica freeway and continue directly into Santa Monica where we will join Hiway 1 and pick up Valley V-8ers. Sightseeing will include a stop at an 1800's school house, lunch in the little town of Los Olivos, a stop for shopping and sightseeing in Morro Bay, with our final stop in Cambria for the night.

*** MOTEL: San Simeon Pines pho 805-927-4648

SECOND DAY - FRIDAY, AUGUST 3: We will tour over scenic State Hiway 46 to Paso Robles, where several Victorian homes and other attractions await us. We will have breakfast at The Bakery Works, a quaint, small cafe in the center of town. Then we'll proceed north on Hiway 46, stopping in Cholame to view the monument erected by a Japanese business man in the memory of James Dean. Our destination for the night will be Fresno.

MOTEL: Ramada Inn Ask for Early Ford V-8
pho 209-224-4040 Club group rate

THIRD DAY - SATURDAY, AUGUST 4: This morning we will tour the Meux Museum, located in a restored Victorian mansion located only a block from our motel. The tour will then proceed north on US 99 with our next stop being the Castle Air Museum in Atwater. Lunch will follow at Turlock Reservoir, the day ending in Sonora.

MOTEL: Best Western Sonora Oaks pho 209-533-4400
alternate motel: Sonora Town House Motel

*** IMPORTANT: The San Simeon Pines requires a written reservation request. P.O. Box 117, San Simeon, Ca 93452 Attn Janet - Manager

Harris tour to Reno continued.....

FOURTH DAY - SUNDAY, AUGUST 5: Today we will start out after breakfast with a tour of the historic mining town of Columbia, located not far from Sonora. Then we will head up State Hiway 49 through the 'Gold Country', stopping in Sutter's Creek, Dry Town, and at the gold discovery spot at Marshall Gold Discovery Historic Park located 8 miles north of Placerville. Our day will end in Grass Valley.

*** MOTEL: Best Western Gold Country Inn pho 916-273-1393
11972 Sutton Way. Exit Brunswick off of Hiway
49.

FIFTH DAY - MONDAY, AUGUST 6: This morning we will tour east on State 20, a scenic route that will unite us with I-80 and a two hour ride into Reno where we will join the first day activites of the Western National Meet 'RENO IN NINE OH'

If you plan to join me on our tour to Reno I urge you to make motel reservations early to avoid disappointment. This year's tour includes more sightseeing and fewer miles per day than prior tours, and is sure to be enjoyable. You may call me during the day at 714-553-1733 for answers to any tour questions, or in the evening at 714-586-4150 between 7 and 8 PM. HAPPY TOURING!!

JAY HARRIS

*** REQUEST ROOM NUMBERS 63-82

MENTION THE EARLY FORD V-8 CLUB
IN ALL OF YOUR CORRESPONDENCE

CALENDAR OF EVENTS

- Mar 4 Regular meeting, Mercury Savings,
Magnolia & Laurel Canyon, 7:30 P.M.
Tire kicking at 7:00
- Mar 11 Swap meet at Veteran's Stadium,
Long Beach
- Mar 25 Early Times Car Club car show & swap
meet at Mattel parking lot, Hawthorne
- Apr 1 Regular meeting, Mercury Savings
- Apr 6-8 Portland swap meet
- Apr 8 Swap meet at Veteran's Stadium,
Long Beach
- Apr 22 Spring car show at Woodley Park,
sponsored by CHVA, registration \$10
Chuck Shubb 818/882-2927
- Apr 29 Fabulous Fords Forever car show at
Knotts Berry Farm, 818/343-2091
- May 19 Tour to the Queen Mary, Voyage to
1939
- Aug 2-6 Jay Harris tour to Reno, 714/553-1733
days, 714/586-4150 between 7 & 8 PM
- Aug 6-10 Western National Meet at Reno

REGISTRATION FORM

WESTERN NATIONAL MEET

“RENO in NINE oh”

AUG. 6-10, 1990 RENO, NEVADA

Registration # _____

Name _____ Spouse _____

Address _____

City _____ State _____ Zip _____

Children (names & ages) _____

Teens willing to baby sit for pay _____

Regional Group _____

I will help with judging _____ CLASS _____

Experience _____

Year & Model of car(s) bringing to meet _____

- CLASS: [] CONCOURSE [] TOURING [] DEARBORN [] DISPLAY [] ORIGINAL [] NOT ENTERED

PRICES:

Table listing registration fees: Early Registration (\$35.00), Late Registration (45.00), Extra car in judging (10.00), Ladies Brunch (17.00), Concourse Lunch (7.00), Barbeque (15.00), Awards Banquet (25.00), T-Shirts (10.00), Meet Hat Pin (5.00), Ladies Necklace (8.00), Shift Knob (10.00), Hawaiian Vacation (\$1.00 ea./6 for \$5.00), Children's registration (10.00), Wild Water Slide Park (12.00), Planetarium & Skate night (12.00), TOTAL \$ _____

Please send a PEPPERMILL REGISTRATION ENVELOPE: _____ (needed for a Hotel registration at host hotel)

MAIL TO: DANIEL WITTERN 1768 BOBWHITE RD. LIVERMORE, CA 94550

Make Check payable to: RENO IN NINE OH

CARS AND PARTS WANTED

41 Mercury, 39 Ford Std. Tudor, 41 Chev,
41 Studebaker, 46-47 Hudson Commodore 8 W/OD,
52-54 Hudson Hornet, other prewar cars con-
sidered. Will swap 82Peugeot 604 TO, 74 Chrys.
Imperial, 73 Citroen SM 5 speed, 61 Panhard
PL 17. My cars are 1.5 to 2 condition and cars
wanted must be in 2 or better condition. Can
add cash, accept trade in plus cash depending
on value. Prefer trading 2 cars for one to
gain storage. William Toensing 818/547-6051
home, 818/753-6542 work

VINTAGE CARS DRIVEN TO THE FEBRUARY MEETING

Dennis Keene	40 Ford Deluxe Coupe
Harold Johansen	32 Ford Roadster
Harold Selson	36 Ford Coupe
Bill Woods	40 Mercury Club Coupe
John & Virginia Wolf	40 Ford Deluxe Coupe
Chuck Mair	41 Ford Coupe
Bill Toensing	41 Ford Tudor

>>>> MARCH <<<<<
>>>>>>>>> BIRTHDAYS <<<<<<<<<<<

March 1 - Gordie Chamberlin

March 9 - Tony Di Meo

March 18 - Ruth Mottern

March 25 - Kent Lowry

March 30 - Polly Mair

March 30 - Ruth Thompson

<<<< Happy Birthday to All of you. >>>>

Please let us know when your Birthday is !

Your Name: _____

Your Birthday: _____

Spouse's Name: _____

Spouse's Birthday: _____

Fill out the above information and mail to:

Virginia Wolf
13024 Hartsook Street
Sherman Oaks, CA 91423

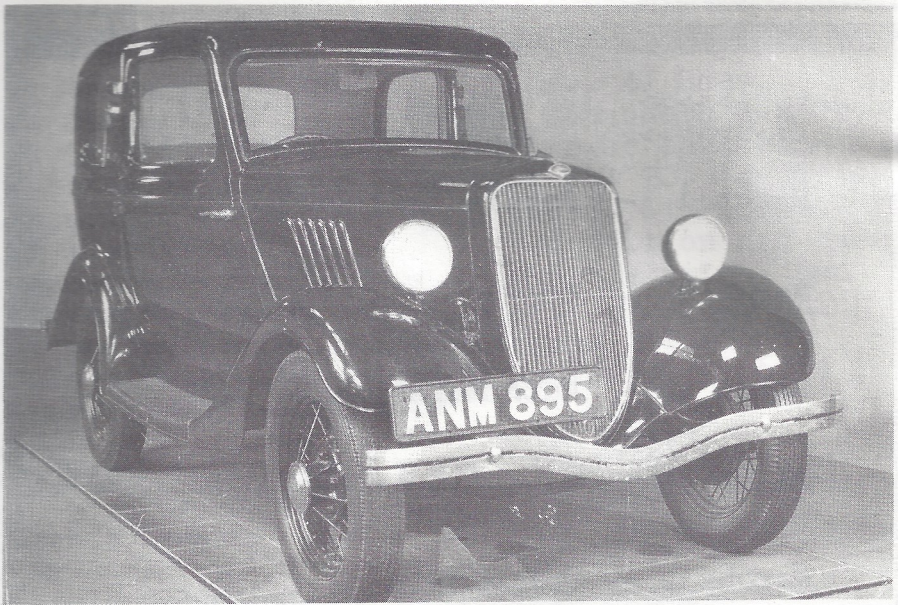

Formerly
Chick Hart
Printers

DiFATTA

Graphics

Specializing in
Complete Quality Printing

OFFSET · 25" MAX · COMPLETE BINDERY SERVICE
TYPESETTING · GRAPHIC DESIGN · EMBOSING
DIE CUTTING · FOIL STAMPING · CAMERA WORK

30 Years
Serving The Valley

5920 LEMONA AVENUE · VAN NUYS, CA 91411 · (818) 782-9883

UNIQUE REALTY SERVICES

LOANS
&
SALES

Ben Difatta
Vice President • Managing Broker

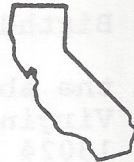

FAX (805) 259-2943
Bus. (805) 259-5096
Res. (805) 716-5583

24502½ LYONS AVE.
NEWHALL, CA 91321

CLASSIFIED

Auto - Homeowners -
-ARTICLE CARE-
ED HARDIN INSURANCE
Business - Life Health - Aircraft



Call us for your insurance needs
(818) 368-5683

L. T. "LEE" SAWYER, INC.

Jobber

Shell Oil and Chemical Products

TOM SAWYER

14117 Aetna St. Box 369
Van Nuys, California 91408
Telephone (818) 786-8180 785 0902

NEW DONATER OF MONTHLY CASE OF MOTOR OIL
TO OUR CLUB. THANK YOU, TOM SAWYER.

The Prudential



California Realty

13400 Ventura Blvd.
Sherman Oaks, California 91423
Bus. (818) 788-5400
Res. (818) 761-1734
FAX (818) 784-4926

AL SPENCER
Broker Consultant



MAIR GLASS SERVICE

15140 Valerio Street
Van Nuys, California 91405
786-5008 • 785-9413

DON'S Auto Parts

MACHINE SHOP and BALANCING

Monday thru Friday 9 a.m. to 8 p.m.
Saturday 9 to 6 - Sunday 10 to 4

Domestic &
Foreign

Parts & Supplies



894-6441

10241 Woodley (At Devonshire), Sepulveda



NEW &
RECONDITIONED

NO. HOLLYWOOD BATTERY
HIGHEST QUALITY FOR MAXIMUM
PERFORMANCE & LONG LIFE

Correct 6 Volt Sizes
For Early V-8's

10748 Burbank Blvd.
No. Hollywood, Ca. 91601
(818) 766-5530

AUTO
TRUCK
MOTORCYCLE
MARINE

COUNTRY ROAD AUTOMOTIVE

CUSTOM FLATHEAD ENGINES
STOCK OR STREET LETHAL

JACK MILES
(818) 347-8617

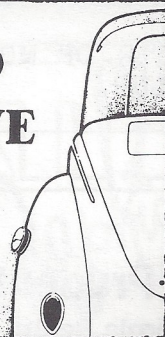

RUSS' TRANSMISSIONS
Transmission Specialists

DON'T CUSS * CALL RUSS

7760 Balboa Blvd.
Van Nuys, CA 91406

RUSS SYLVIS
(818) 901-9500

PAST PRESIDENTS

JIM ROWE.....	1971-72
DOUG PETERSON.....	1972-73
DON DURKEE	1974
ED WARNOCK.....	1975
JOHN BUSK.....	1976
CHIP WERSTEIN.....	1977
STAN MASRAJE	1978
BOB DRAKE	1979
BILL CULP.....	1979
AL SPENCER.....	1980
LARRY CAPLAN	1981
BOB ROSE	1982
DON DURKEE	1983
PAUL KIRK	1984
KENT LOWRY	1985
DAVE SANBORN.....	1986
JOHN KEMMERER	1987
DUDLEY OCHSNER	1988
JERRY JENSEN	1989

MEETINGS: Mercury Savings and Loan
Magnolia and Laurel Canyon Blvd.
- 1st Sunday of Every Month -

The Valley  **'s**

P.O. BOX 96 — RESEDA, CA 91335

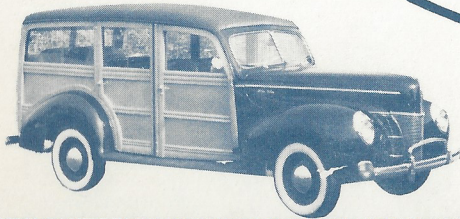
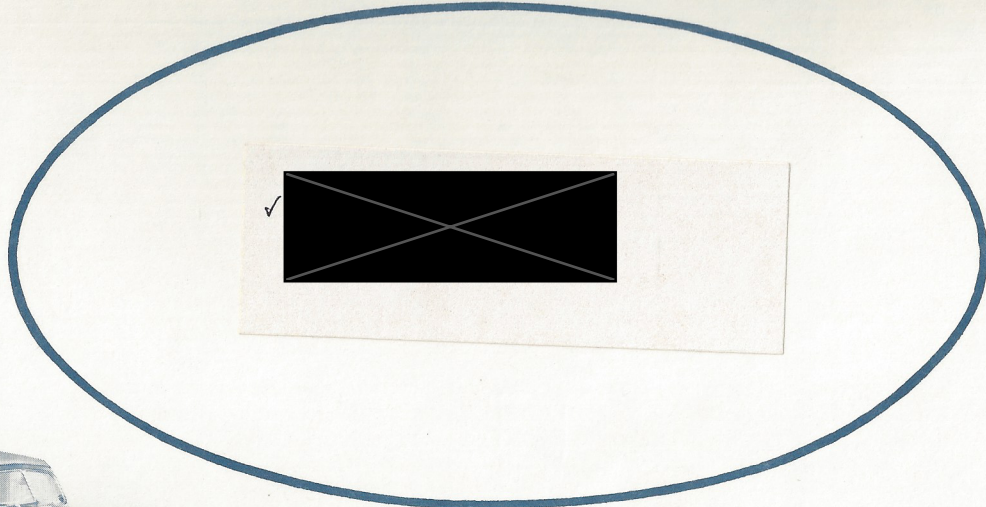
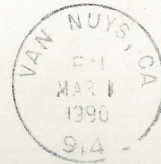

1940 WOODY