

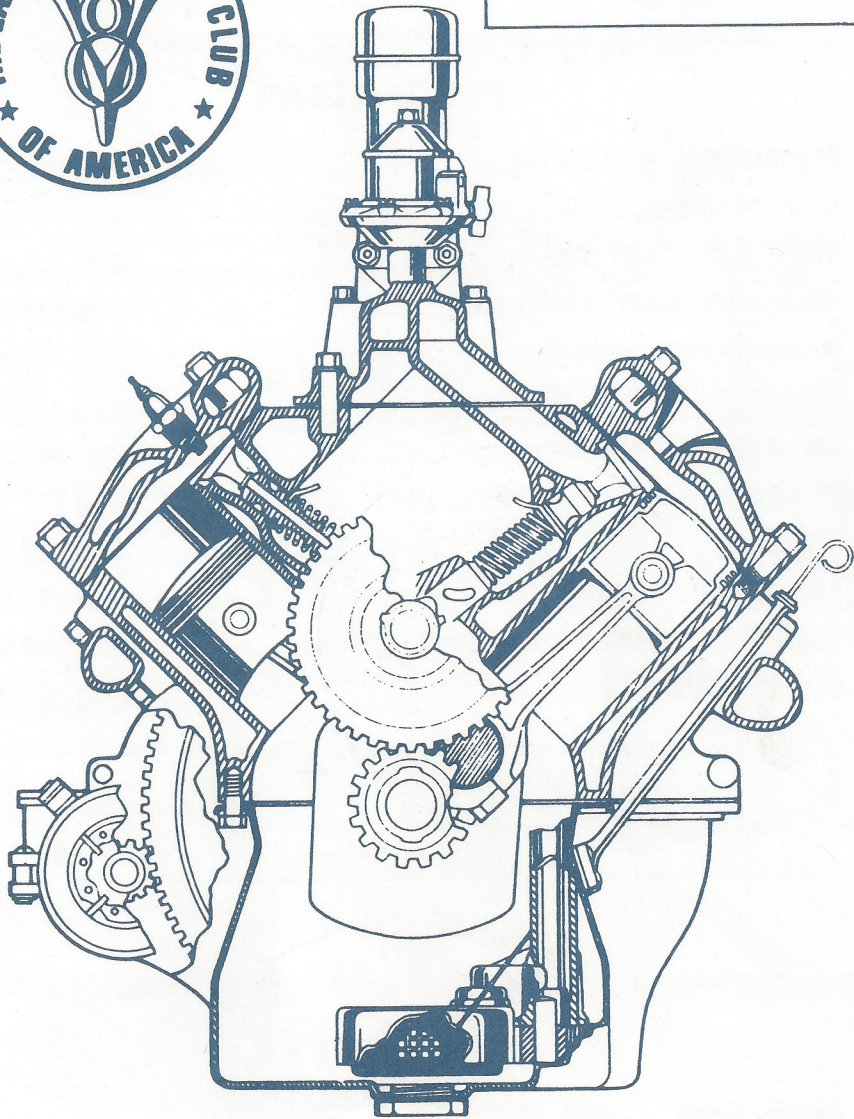

JUNE



Drive Lines

The Valley 's

1992 OFFICERS

PRESIDENT, CHUCK SHUBB.....	(818) 882-2927
VICE PRESIDENT, GEORGE RICHARDS.....	(818) 992-4537
SECRETARY, JERRY JENSEN.....	(818) 886-5711
TREASURER, KENT LOWRY.....	(818) 368-9830
ACTIVITIES, JIM WINNETT.....	(818) 768-4228
ACCESSORIES, TOMY THOMPSON.....	(818) 841-7967
MEMBERSHIP, TERRY SMITH.....	(818) 989-3119
FELLOWSHIP, DONNA PASCHAL.....	(805) 527-6464
RAFFLES / HISTORIAN, JERRY LITTNER.....	(818) 347-1194
EDITOR, CHUCK MAIR.....	(818) 785-9413
ASSISTANT EDITOR, JOE DiFATTA.....	(818) 782-9883
PROGRAMS, LARRY CAPLAN.....	(818) 363-2849

TECHNICAL ADVISORS

DON DUPREE
(818) 883-2747

DON DURKEE
(805) 495-5298

Drive Lines

Published By

SAN FERNANDO VALLEY CHAPTER 40
of the EARLY FORD V8 CLUB OF AMERICA

P.O. Box 96
Reseda, CA 91335

COVER/ROY JONES

The Valley V8's

JUNE 1992

PRESIDENT'S MESSAGE

President Chuck Shubb says

Due to unfortunate circumstances the May Meeting was cancelled. We will arrange a future date to have Bert Boechmann, owner of Galpin Ford, to speak to us.

The June meeting is back at Western Federal, same time as normal - 7 p.m. Tire Kicking and 7:30 the meeting. We have an interesting speaker who will be telling us all about early Ford Heaters. See Larry Caplan's column for more details.

May 31st is the W.P.C. Swap Meet at Pierce College upper parking lot. V8'ers can sell for \$10.00 space or cars at \$5.00 a space. Call Jack Pinsker for more information. Days (818) 760-3682 or Eves. (818) 769-5190.

Saturday, June 6th we are invited to the Motion Picture Home Parade Car Show & BBQ. This is a fun event. Lets get the cobwebs off those Early V8's and participate. Let's all support this event. Participation is the secret to getting the most out of your club.

I need input from our members. What kind of activities are you interested in having? Your leadership would like to provide you the type of club you want; Tours, Visit Car Collections, Museums, Car Shows...What do you want? We will discuss this subject at the meeting.



JACKPOT

\$20.00

Could Be Yours!

(You just have to be present and wear your name badge to win.)



MAY 3RD WEEKEND A REAL BORE!!

Two Car Shows, Bob's Drive Inn and a Swap Meet at Pierce College (now rescheduled to May 31st) were cancelled. The 55-56-57 Chevy Club with their money maker car show was also cancelled because of the riots in L.A. They actually contribute a large portion of their funds to a handicap program in the West Valley.

Personally, whose ever right or wrong is hard to establish. We have our opinions. Lots of problems that have been "brewing" that really hit the fireworks stage. Whatever was cooped up in the closet is out in the open now.

Can we get back to normal? Can our kids walk the sidewalks to school and feel safe? Are our businesses safe? Let's hope, we can stay together as a unit and strive for the best.

Just recently I went to see and hear the new Chief of Police Willie Williams speak at a breakfast at the Universal Hilton. He spoke of unity, a better understanding of our people. He, personally, is studying every aspect of our area, our police department. We have a great police force. Besides being a big man, he looks like he can wave a big stick, however, I believe he will bring law and order and confidence back to our city.

Thank you for reading,

Joe Di Fatta

A FIELD OF DREAMS...WILDFLOWER TOUR '92

By: Lesley Littner

...Because of the early and heavy rains in February and March of this year, my first instinct was that our Club's Wildflower Tour on April 26th - was "a day late and a dollar short".

But, being the optimist I am, and knowing for many years about the beautiful hillsides and mountains we were heading to...I packed the picnic baskets and looked beyond the late timing and towards the smell of spring. Winter never takes away what spring starts anew. The beauty we saw was a beginning...and dreams can still come true.

Our gang met at Woodley Park, where we were joined and directed by Pat Berry, to our primary and ultimate destinations of the tour. We all stopped at Lake Hughes to enjoy our packed picnic lunches - while the cool breezes danced off the water to soothe and refresh our caravan. After our tummies were full and our radiators cooled, (the mountain drive was not the easiest for some of the old iron), we headed up-slope again towards the summit that separates the eastern-most side of Lancaster and the mountains just to the east of Gorman. We passed the usual tourist stop - the "Wild Poppy Reserve" - where dozens of cars were parked and abandoned along the roadside. Continuing on a little further, we turned onto a dirt road. There, before our eyes was an incredible field of rust and orange Poppies! We all stopped and got out to view and stroll through this private patch of spring splendor. Our wonderful host, Pat, had made prior arrangements with the owner of the land for our visit. Everyone seemed to marvel at the sight of Mother Nature's ability to turn an otherwise brown-beige slope into this field of glorious color. After sufficient time to wander through the flowers and take lots of photos, we all headed off toward home. The route many of us took was to continue on the northwest highway. Along the way to the freeway, we saw rolling hills of purple, yellow and red. It was a delightful ride and a wonderful day!

Thank you to all who made it so enjoyable. We can hardly wait 'till next year to do it again.

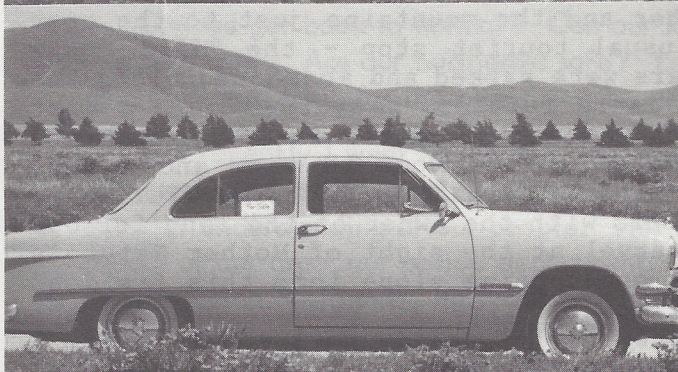
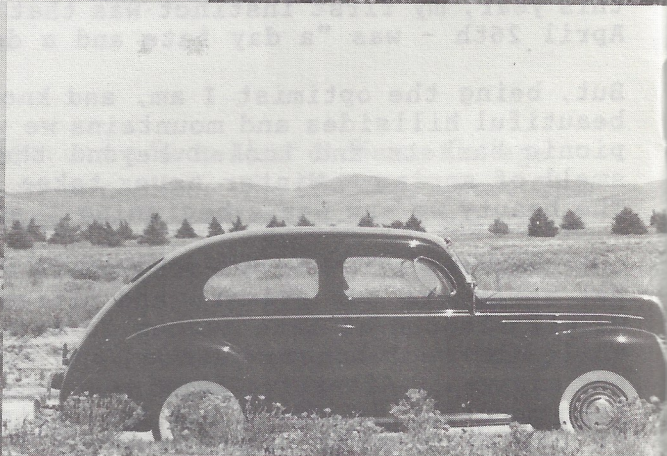

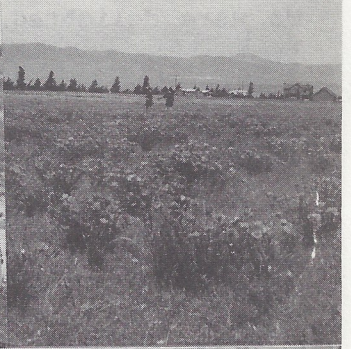
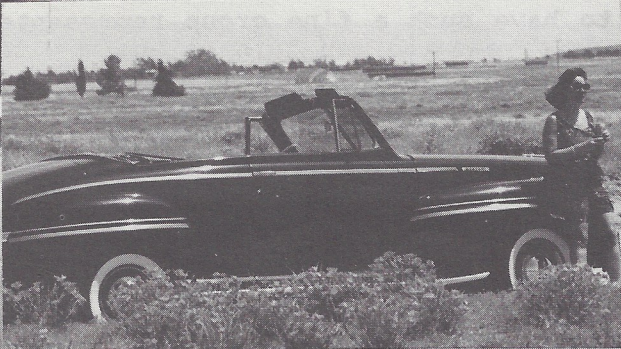
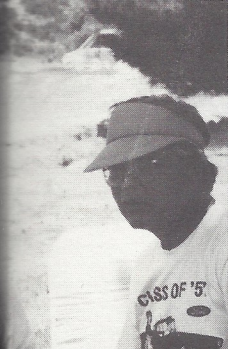

REFRESHMENTS FOR JUNE will be supplied by ALLAN FRANKLIN

ORDER YOUR V8's
CLUB SHIRTS NOW for
the Summer
CONTACT: TOMY THOMPSON
(818) 841-7967

ARTICLES and PICTURES
are needed for
"DRIVE LINES"

Contact JOE DIFATTA. We can
also reproduce magazine or book
articles.

ATTENTION: ALL MEMBERS
WHO READ THE MAR/APR
V-8 TIMES

DON'S AUTO PARTS ...CARRIES:
CHAMPION UD - 16
SPARK PLUGS
(FOR: 1933-1937 V-8'S)
(W/ .025 GAP)

1946 PASSENGER CAR MODELS

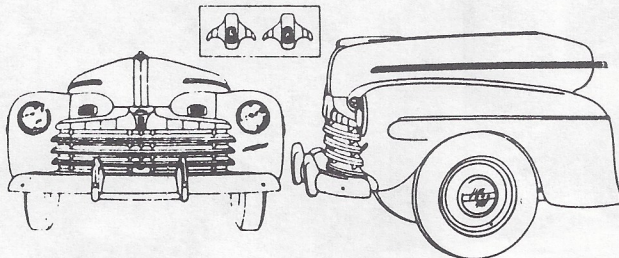

MODEL 69A FORD DELUXE OR SUPER DELUXE 100 HP. 8-CYLINDER ENGINE
MODEL 6GA FORD DELUXE OR SUPER DELUXE 90 HP. 6-CYLINDER ENGINE

SUPPORT OUR ADVERTISERS!

L.T. "LEE" SAWYER, INC.

Jobber
Shell Oil and Chemical Products

14117 Aetna Street, Box 369
Van Nuys, California 91408
TOM SAWYER (818) 786-8180 / (818) 785-0902

RAFFLE PRIZE DONOR

The Prudential



California Realty

13400 Ventura Blvd.
Sherman Oaks, California 91423

Bus. (818) 788-5400
Res. (818) 761-1734
Fax. (818) 784-4926

AL SPENCER
Broker Consultant



SUSAN E. MILLER, GRI

Realtor-Associate®
Multi-Million Dollar Producer

PARAMOUNT PROPERTIES

19300 Rinaldi Street, Northridge, California 91326
BUS: 363-4997 FAX: 360-5282 PGR: 377-5811

(818) 763-8266
(213) 877-0197



JULES AUTO PARTS

Complete Machine Shop
Classic and Modern Engine Repairs
Engine Rebuilding and Parts

BOB CAMPBELL
SHOP FOREMAN

10452 MAGNOLIA BLVD.
NO. HOLLYWOOD, CA 91601

Grant Studio
SINCE 1940
PHOTOGRAPHY

GRANT R. LIPPERT

14625 Victory Boulevard
Van Nuys, California 91411
785-6554

DAVID'S
VENDING
SALES AND SERVICE

DISTRIBUTOR FOR:

Cavalier
WITTENBERG

LETRAVEND

BREWOMATIC
HAMILTON

coinco • Amone

800 S. San Fernando Blvd
Burbank, California 91502

(818) 848-8703

DAVID SATEL

Flips
TIRE CENTER

FLIP SMITH

Formerly
GLOBE TIRE

7735 Sepulveda Blvd.
Van Nuys, CA 91405
(818) 786-8686

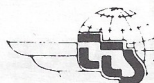

KAREN WETTERLIND
Asst. Manager

"The World Is Our Gem"

tiffany travel service

15226½ Ventura Blvd. • Sherman Oaks, Ca. 91403-3374
S.F. Valley (818) 990-3400 • L.A. (213) 872-3818
TELEX 4951124 TIFF UI

SUPPORT OUR ADVERTISERS!

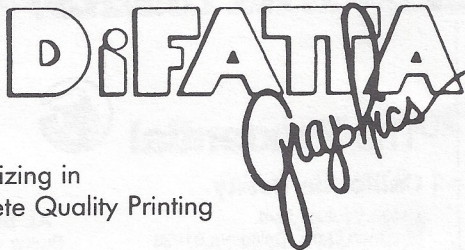

Specializing in
Complete Quality Printing

5920 LEMONA AVENUE • VAN NUYS, CA 91411
(818) 782-9883

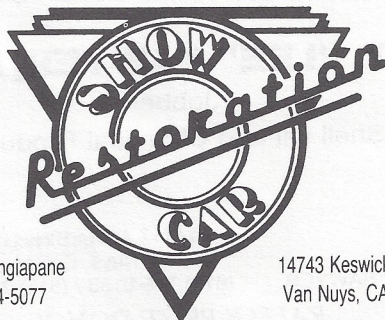

John Mangiapane
(818) 994-5077

14743 Keswick Street
Van Nuys, CA 91405

DON'S
Auto Parts

MACHINE SHOP and BALANCING

Monday thru Friday 8 a.m. to 7 p.m.
Saturday 9 to 6 - Sunday 10 to 4

10241 Woodley (At Devonshire)

Domestic &
Foreign

Parts & Supplies



(818)
894-6441

Sepulveda, CA 91343

RAFFLE PRIZE DONOR

Collector's CARS
COMPLETE
AUTOMOTIVE
REPAIR
SERVICES

Mike Toshima • Greg Garcia

(818) 447-2576

150 East St. Joseph Street, Arcadia, CA 91006

ST. LICENSE #462714

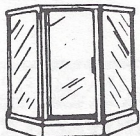

ARNIE LIEBOWITZ

TOTAL GLASS WORKS

(818) 780-4000

- ★ CUSTOM MIRRORS
 - ★ SHOWERS & STEAM ENCLOSURES
 - ★ COMMERCIAL STOREFRONTS
 - ★ SOLARIUMS
 - ★ TEMPERED GLASS
 - ★ WINDOWS SCREENS & SCREEN DOORS
- 14647 ARMINTA ST. - PANORAMA CITY, CA

Auto • Homeowners

- ANTIQUE CARS -

ED HARDIN INSURANCE

Business • Life • Health • Aircraft



Call us for your Insurance needs!

(818) 363-7864



RUSS' TRANSMISSIONS

Transmission Specialists

DON'T CUSS • CALL RUSS

7760 Balboa Blvd.
Van Nuys, CA 91406

RUSS SYLVIS
(818) 901-9500

TRISTAR
TRUST DEED NOTE CO.

BEST PRICES
FAST CASH
BUY / SELL



TRUST
DEED
INVESTMENTS

BEN DiFATTA

Phone / Fax
818-716-5583

Pager
818-417-2336

PAST PRESIDENTS

JIM ROWE	1971
DOUG PETERSON.....	1972
DON DURKEE.....	1974
ED WARNOCK.....	1975
JOHN BUSK	1976
CHIP WERSTEIN.....	1977
STAN MARSRAJE.....	1978
BOB DRAKE.....	1979
BILL CULP	1979
AL SPENCER.....	1980
LARRY CAPLAN.....	1981
BOB ROSE.....	1982
DON DURKEE.....	1983
PAUL KIRK.....	1984
KENT LOWRY	1985
DAVE SANBORN	1986
JOHN KEMMERER.....	1987
DUDLEY OCHSNER.....	1988
JERRY JENSEN	1989
JERRY JENSEN	1990
JOE DiFATTA.....	1991

Meeting are held on the first Sunday of every month at:

WESTERN FEDERAL SAVINGS
12175 Ventura Boulevard — 2nd Floor
Studio City, California

The Valley  **'s**

P.O. BOX 96 — RESEDA, CA 91335

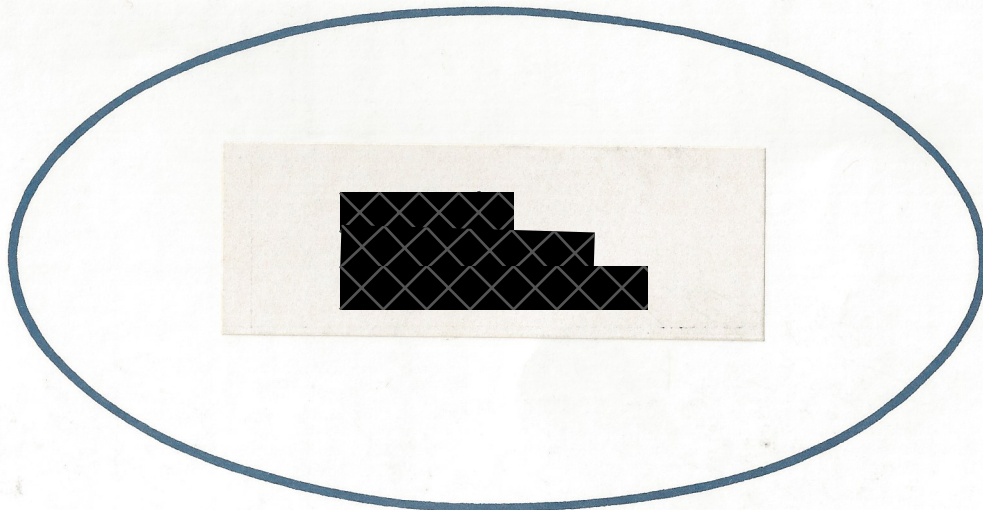
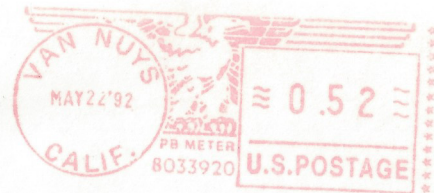

1942 WOODY