

94

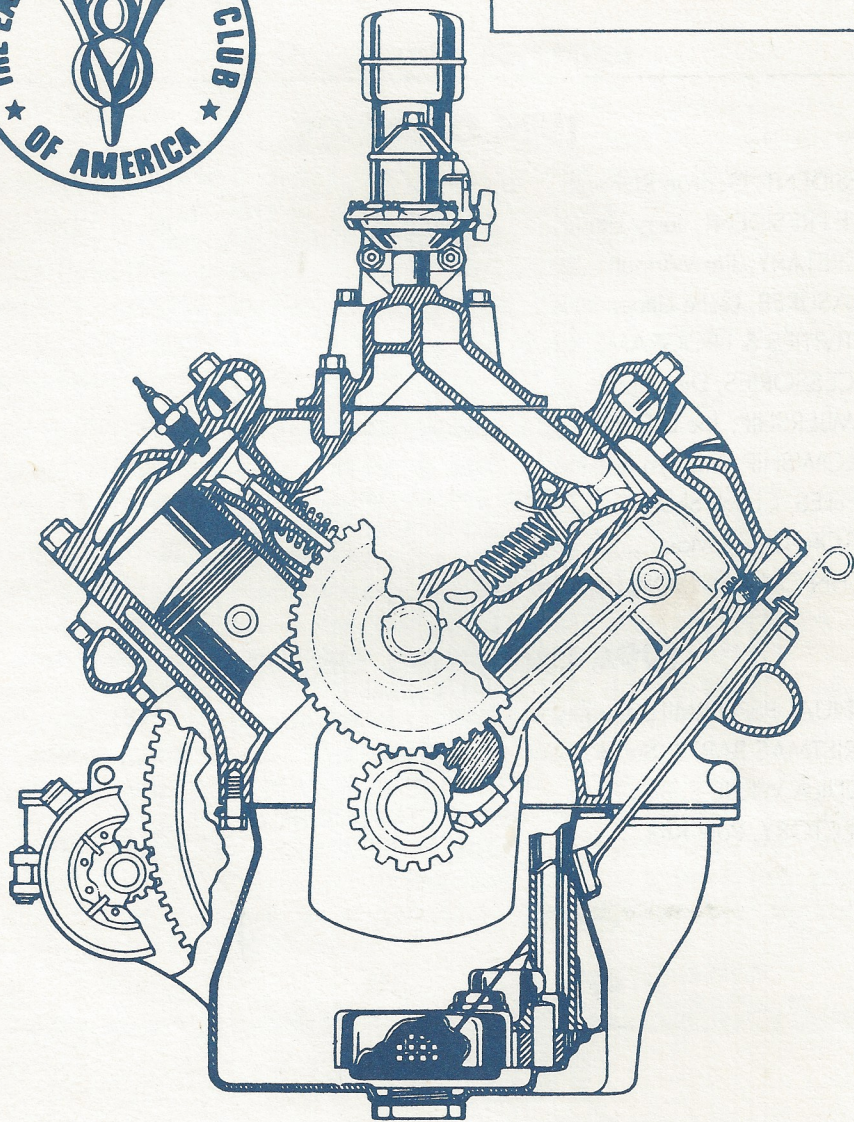

AUGUST



Drive Lines

The Valley s

1994 OFFICERS

PRESIDENT, George Richards	(818) 992-4537
VICE PRESIDENT, Jerry Littner	(818) 347-1194
SECRETARY, Jim Winnett	(818) 768-4228
TREASURER, Leslie Littner	(818) 347-1194
ACTIVITIES & PROGRAMS, Chuck Shubb	(818) 882-2927
ACCESSORIES, Dick Smith	(818) 993-9538
MEMBERSHIP, Joe DiFatta	(818) 782-9883
FELLOWSHIP, Marilyn Salkin	(805) 527-4387
RAFFLES, Chuck Shubb	(818) 882-2927
EDITOR, Chuck Mair	(818) 785-9413
TECHNICAL ADVISOR, Don Dupree	(818) 883-2747

1994 Committee Chairmen

ANNUAL PEPPERMILL, Dudley Ochsner	(818) 446-1206
CHRISTMAS PARTY, Santa Claus	(800) SANTA 25
TEQUILA WILLIE'S, Bob Rose	(818) 362-4842
DIRECTORY, Paul Kirk	(818) 886-5467

Drive Lines

Published By

SAN FERNANDO VALLEY CHAPTER 40
of the EARLY FORD V8 CLUB OF AMERICA

P.O. Box 96
Reseda, CA 91335

COVER/ROY JONES

The Valley V8's

SEPTEMBER 1994

President's Message

Our big event for July was the combined meeting and Barbeque at the home of Beverly and Don Dupree. Over 70 people attended, great turn out! It was good to see so many long time members as well as all the newer ones. Thanks to all for brining your beautiful Fords for all to enjoy. Ed Warnocks '32, as well as Fords from '34 to '47, all the great little trucks and even Kent's '57 Skyliner really gave the event incredible class.

You should have seen the spread. WOW. From hamburgers and hotdogs to shrimp and salads. Lots to drink and super "make your own sundae" deserts. I saw some mighty big ones. (Was that on the diet?) Much thanks to Beverly and Don for all the work and expense they put into this Bang up Barbeque. You two were great hosts and we thank you again. But don't forget the cooks, Leslie and Marilyn. It was a hot job and they did it in style. Super! Thanks to Shirley for making the bingo game go so well.

There will be no meeting in August due to the many vacations and the National V8 meet. The Richards will be going to Silverdale, Washington for the Lincoln Continental Owners Western National meet and then on to Canada. About two weeks in all. Our next meeting will be on September 4. Chuck Shubb has a super auto museum tour set up. You won't want to miss this chance to share this trip with your friends. And last but not least, don't forget the annual Peppermill Restaurant meet on September 11. Time is running out. For tickets, send your money to Dudley Ochsner. Watch for a sign up sheet in the next issue of Drive Lines. See you all on September 4 for another very good time. The Valley V8's really know how to do it.

Your President,
George Richards

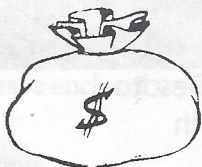

JACKPOT

\$20.00

Could Be Yours!

(You just have to be present and wear your name badge to win.)

Sunday, September 4th meeting will be held at the

**CONGREGATIONAL CHURCH HALL
9659 BALBOA BLVD., NORTHRIDGE**

TIRE KICKING: 7:00 P.M.

MEETING: 7:30 P.M.

**Mark Your Calendar
Holiday Party
Sunday, December 4th, 6:30 p.m.**

PETERSEN AUTOMOTIVE MUSEUM

Saturday, September 17

Petersen Museum Interclub Tour — Drive your old car and wear your Name Badge and receive free parking (normally \$4.00). Special club admission is \$5.00 per person. We will meet in Woodley Park (where our Spring Car Show is held) at 11:30 a.m. Call Chuck Shubb for information. (818) 882-2927.

UPCOMING TOURS

**Fri., Aug. 12
7:00 p.m.**

Cruise Nite, Cruiser's Car Wash
8870 Tampa Ave., Northridge
(in front of the Price Club building)
Also 50's style restaurant inside

Sun., Aug. 21

Model T Ford Swap Meet
Main & Placentia, Riverside

Sun., Sept. 4

Regular V-8 meeting

Sat., Sept. 17

Petersen Museum Tour

**Sun., Sept. 18
6 a.m. - 3 p.m.**

Model T Swap Meet, Plummer & Desoto
"Rancho San Antonio", Chatsworth

**Sun., Sept 18
10 a.m - 3 p.m.**

Car Show - Verdugo Vintage Vehicles
La Crescenta Park, Glendale



Early Ford V-8 Club of America

Valley V-8's Host

PEPPERMILL BRUNCH 1994

795 E. Walnut St.

Pasadena, CA 91101

Baldy View

Best of Show

\$9.75 per person

Ventura

Prizes

Sunday, September 11, 1994

Southern Cal

Awards

Tire Kicking 9:30 a.m.

Doors Open 10:00 a.m.

San Diego

Fun

Brunch Served Promptly at 10:30 a.m.

RSVP by 9/6/94

Make and mail checks to :

Dudley C. Ochsner

750 East Green Street, Suite 302

Pasadena, CA 91101

(818) 793-5104

Yes I will attend the Peppermill 1994, Sunday, September 11

I have enclosed my check for the amount of _____ for _____ people

Name _____ Phone _____ Regional Group _____

Tickets will be held at the door and can be picked up after 9:30

FALL CLASSIC TOUR

NOVEMBER 4, 5, 6

This year will be a real "Travelin' Tour"

AGUA DULCE to CALICO GHOST TOWN
to LAUGHLIN to PRESCOTT

FRIDAY

Breakfast in Agua Dulce with a preview opening of the "Country Cottage"

Leave by 9:00 a.m. and on to Victorville, Barstow and "Calico Ghost Town" for Lunch & Shopping (\$5.00 per person)

Laughlin before dark

Please make your own reservations at a hotel of your own choice.

#1. Pioneer 800-634-3469 #2 Ramada 800-2RAMADA

#3. Harrah's 800-HARRAHS #4 Edgewater 800-67RIVER

SATURDAY

Leave Laughlin - 8:00 a.m. (details later)

Stop - Kingman & Yarnell

Arrive Prescott - 12 noon

Check into Hassayampa Inn 602-778-9434

Rooms are \$80-\$90 which includes an evening cocktail and a full breakfast Sunday morning

20 rooms reserved call early (by October 5)

Saturday afternoon we'll visit with one of our transplanted car collectors: Harry & April Vedvik and our own: Coral & Jim O'Leary

Also shopping & sightseeing in Downtown Prescott

Saturday evening banquet at Hassayampa Inn

Approx. \$15.95

This looks to be a jam packed, fun filled weekend

Don't miss out on the fun!

For info call - Gerry Blackwell 805-268-0040



AUGUST V-8 BIRTHDAYS

8/02 STEVE POULOS

8/03 CAROLE JENSEN

8/03 LLOYD PASCHAL

8/04 CHRISTINE VARNEY

8/05 TOM SAWYER

8/05 GRANT LIPPERT

8/07 DENIZE NOLAN

8/10 CANDICE POULOS

8/11 MARY FINLEY

8/11 BRIDGET WINNETT

8/12 JULIA OCHSNER

8/17 CARLOS WILHELM

8/18 DARLENE JANISSE

8/19 GENE WILSON

8/21 KIP COULOMBE

8/23 VICKI KEENE

8/29 K.C. TAUVAGA

8/30 JACK KELEJIAN

V-8 CENTRAL NATIONAL MEET

**JULY 5-8, 1995
NASHVILLE, TN**

The Volunteer Regional Group is hosting the 1995 V8 Central National Meet in Nashville, July 5th through July 8th, 1995.

It's our 25th Annual All Ford Picnic!

What a day we have planned, but we will require your help. The Picnic will be just another picnic without your club joining us. Yes, we need you there, and to prove how valuable your club is to us, the car club that pre-registers the most cards by September 2, 1994 will receive \$100 for their club treasury.

9:00 a.m. - Noon Entry into the park, receive registration packet
Coffee and Donuts served at the Snack Shack

10:00 a.m. - 1:00 p.m. Registration Desk (Receive your dash plaque)
Games with Children and Adults
Hot Dogs, Chips and Sodas served
at the Snack Shack

11:00 a.m. - 1:00 p.m. Judging of the various categories of cards
More Hot Dogs, Chips and Sodas
at the Snack Shack

1:00 p.m. Chinese Raffle
Many More Hot Dogs, Chips and Sodas
at the Snack Shack

2:00 p.m. Trophies Awarded

WATCH THE FORDS GO BY

CARS & PARTS FOR SALE

ITEM	Name / Phone
1964 Lincoln 4 DR. Convertible White with Tan Top/Black Interior Near new tires. New recent mechanical repairs. Includes A/C.	Allan Levine (818) 788-8188
1963 Lincoln 4 DR. Sedan with A/C Near new tires.	Allan Levine (818) 788-8188
6 Volt BATTERY (Pep Boys) + 40 Ford Parts	Joe DiFatta (818) 782-9853
Parting Out. 1939 Ford Pickup parts for sale.	Joe Schubert (818) 885-8581
1937 Ford Club Coupe \$6500	(818) 368-4111
WANTED: '51 Ford Convertible	Bob (818) 908-1428

Suddenly It's 2007!

On June 15, 1957, a Plymouth Belvedere V-8 Sport Coupe with Sportone was slowly lowered into a time capsule on the southeast corner of the Tulsa County Courthouse lawn. The occasion was Tulsa's Golden Jubilee. The car was to remain underground for 50 years, when the person (or his heirs) whose guess was closest to the exact population of Tulsa in 2007 will win the car.

Plymouth was selected for this honor, according to a committee chairman, because it was "an advanced product of American industrial ingenuity with the kind of lasting appeal that will still be in style 50 years from now." Those guys in Tulsa knew what was hot! (Note that they did not bury a '57 Chevy.)

Reportedly, the car was entombed with a full tank of gas (big mistake, guys). In the car were a five-gallon can of gasoline, a jar of Oklahoma crude oil, and a glovebox filled with 14 bobby pins, a lady's compact, plastic rain cap, several combs, a tube of lipstick, a pack of gum, facial tissues, \$2.73 in bills and coins, a pack of cigarettes with matches, an unpaid parking ticket, and a bottle of tranquilizers. In addition, the winner of the "Tulsarama" Plymouth contest will receive a \$100 trust fund that by 2007 will have accrued 50 years' worth of interest.

What will happen when the buried Belvedere is unearthed? Will it still be as pristine as when it went underground? Or will it be rusted away? And will Chrysler still honor the new car warranty?

Well, I sure know where I want to be on June 15, 2007 — alive and well and in Tulsa, Oklahoma. OK!

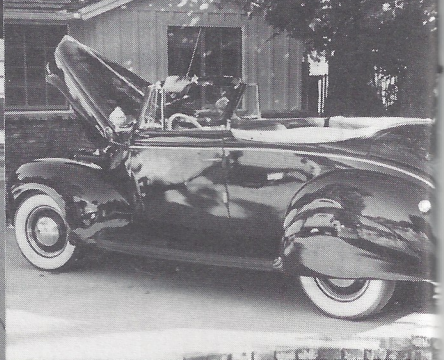
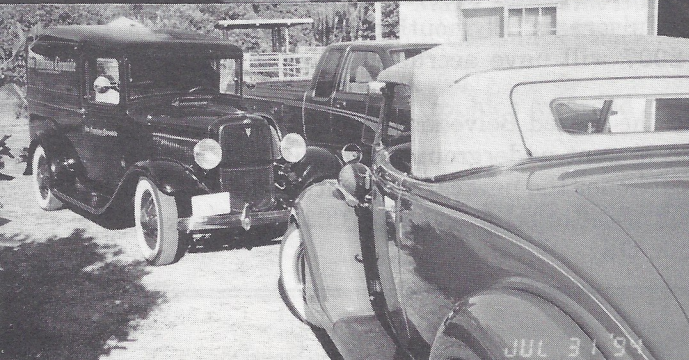
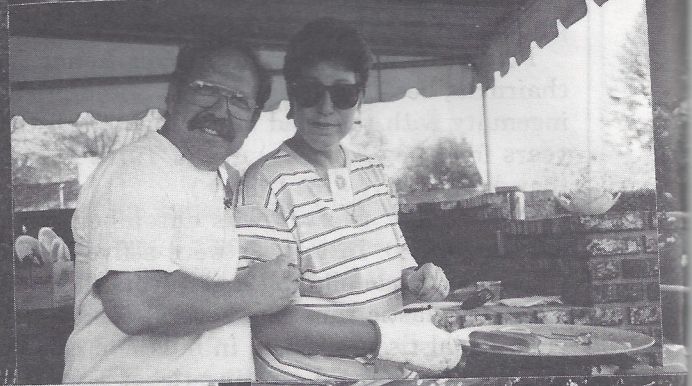
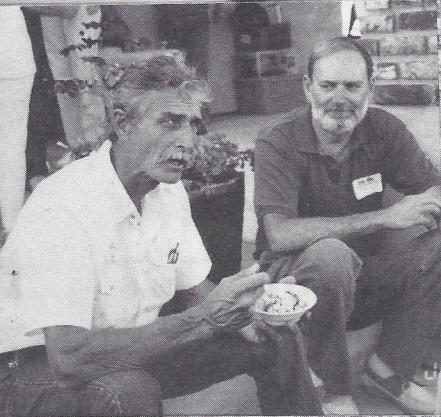
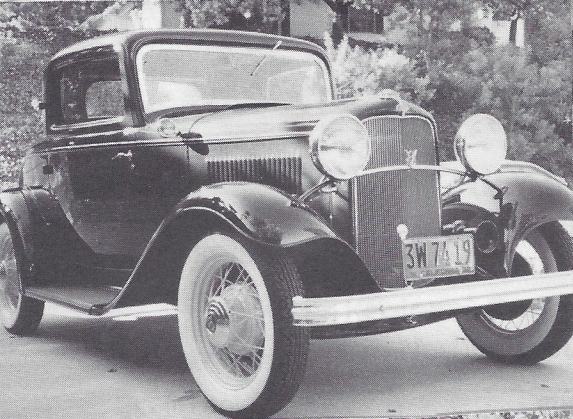

SUMMER BBQ - July 31st

Many thanks to Beverly & Don Dupree for all their work on our annual BBQ. Over 70 people attended and many drove their classics. Thanks to all that assisted.

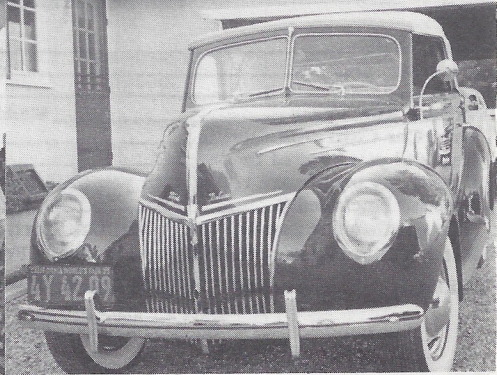
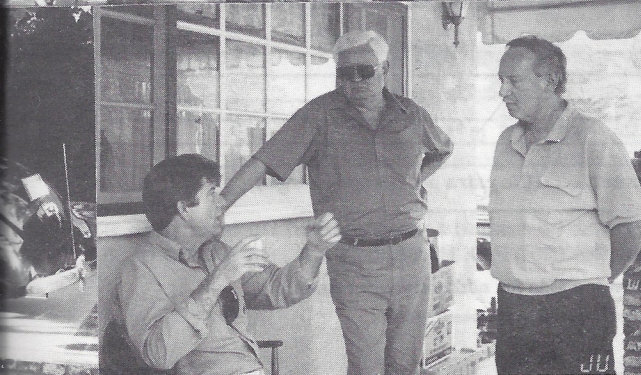
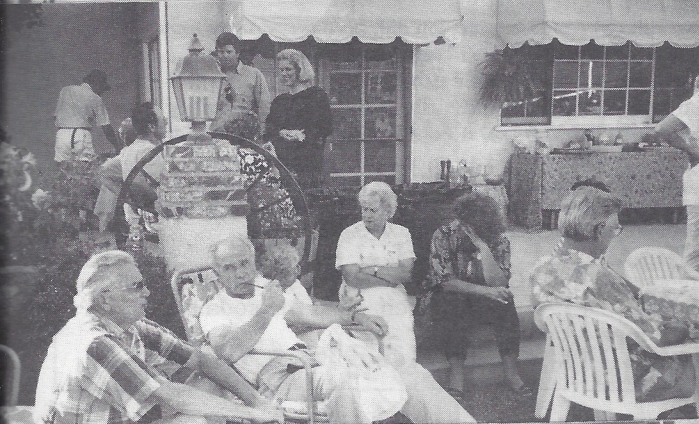
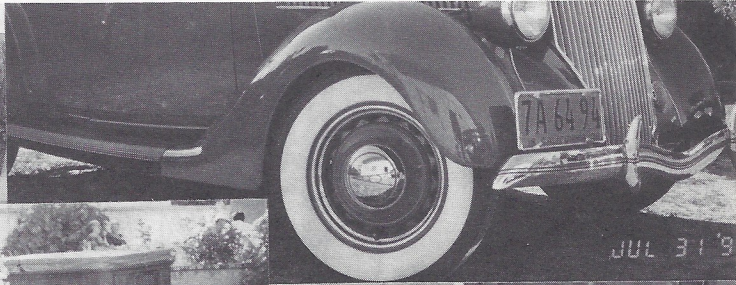

The Early Ford V-8 Club of America -
Southern California Regional Group
invites all years of: Fords, Lincolns and Mercurys to our

25th Annual

Trophies
Door Prizes
Coffee
Doughnuts
Hot Dogs
Soda
Fun
Games

ALL FORD PICNIC

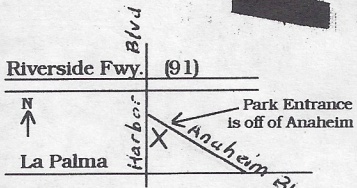
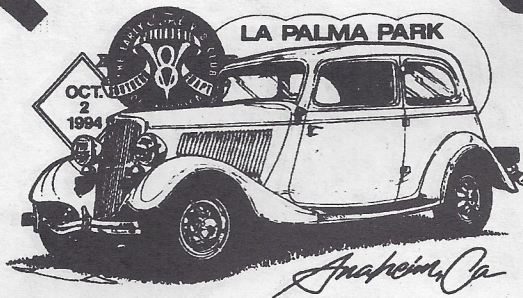

Sunday, October 2, 1994

TIME: 9 am to 4 pm - Come enjoy the day with us! You'll be glad you did, because winners must be present to win: **PRIZES:** 1 pm; **TROPHIES:** 2 pm; **FUN:** all day long.
We'll make it worth your while in two ways to pre-register now:

1. If you send in your pre-registration before the deadline date of September 2nd the per car registration fee will only be \$10.00. Fee after that date is \$15 per car.
2. \$100.00 will be awarded to the car club with the most pre-registration!

Use the form at the bottom of this page to supply the needed info. and mail it (so that it arrives no later than 9/2/94) along with your check made out to the **Early Ford V-8 Club: P.O. Box 39538 L.A., CA 90039-0538.** Need more info? Call: Dennis Keene (213)662-0596, or Fred Herrlein (714)538-3957.

Valuable Coupon

Good for two (2) free raffle tickets with any purchase at the hot dog booth.

Good for one (1) free raffle ticket with any purchase at the soda booth.

Valuable Coupon

----- PRE-REGISTRATION FORM (Please print all information clearly) -----

Your **NAME:** _____ Phone No. _____
Address: _____
City: _____ **State:** _____ **Zip code:** _____
Vehicle info: Year _____ Model _____
Your Car Club affiliation _____
How did you hear of this event? _____
How many people are riding with you to the picnic? _____ (No extra per person charge.)
Amount Enclosed \$ _____ **Date:** _____

(To qualify for pre-registration, this form must be mailed to be received no later than 9/2/94)
Return this lower portion/form to: **Early Ford V-8 Club P.O. Box 39538 L.A., CA 90039-0538**

There is no rain date, therefore no refunds. See reverse side for additional information

SURE START BATTERY

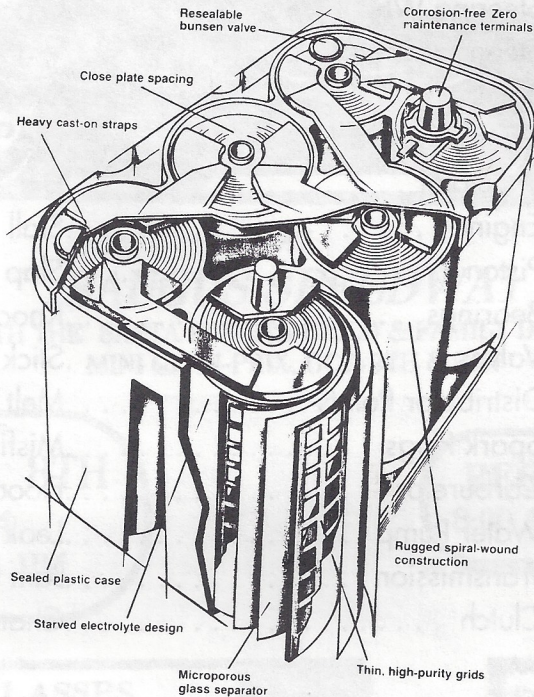

Tests proven to last 3 times longer than
conventional batteries

COST - 6 VOLTS, Approx. \$80

More Info? Call Don at (818) 894-6441

DON'S
Auto Parts

MACHINE SHOP and BALANCING

Domestic &
Foreign

Parts & Supplies



Monday thru Friday 8 a.m. to 7 p.m.
Saturday 9 to 6 - Sunday 10 to 4

(818)
894-6441

10241 Woodley (At Devonshire)

Sepulveda, CA 91343

May Your

Never

..... Horn Button	Stick
..... Steering Wheel	Crack
..... Steering Gear	Wander
..... Battery	Die
..... Generator	Die
..... Regulator	Die
..... Engine	Stall
..... Piston	Slap
..... Bearings	Knock
..... Valves	Stick
..... Distributor Points	Melt
..... Spark Plugs	Misfire
..... Carburetor	Flood
..... Water Pump	Leak
..... Transmission	Jam
..... Clutch	Chatter

Get Well Dept...

- Jack Miles resting after an operation, send a card to his home.
- Cal Beauregard recuperating from a shoulder separation.

SCV SUNRISE ROTARY CAR SHOW

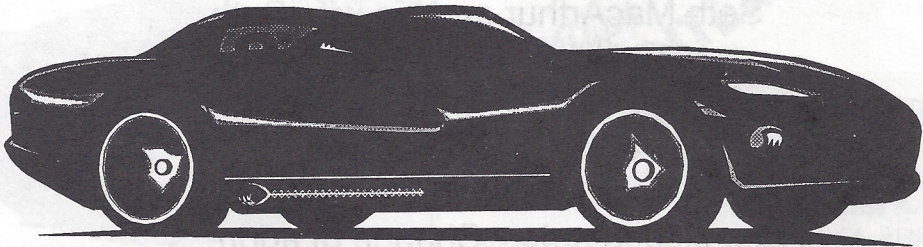

AT

SAUGUS SPEEDWAY

IN ASSOCIATION WITH THE SANTA CLARITA CHILD & FAMILY DEVELOPMENT CENTER'S
MINI GRAN-PRIX, OCT. 7TH & 8TH

Sat. Oct. 8TH
1994
9 AM - 1 PM

REGISTRATION
8:00 AM TO 10:00 AM

CLASSES

A-Antique	G-Street Rod
B-Classic/Stock	H-Best Corvette
C-Commercial	H-Trucks
D-Custom	I-Motorcycles
E-Pro Street	J-Best Special Interest
F-Muscle Cars	K-Best of Show

Raffles

Trophies

T-shirts Available

Food Available

Grand Prize

\$500 Cash or Mexico Cruise for 2!
All entrants eligible by drawing

SCHEDULE OF EVENTS

8 AM Gates Open
10-11 AM All Entrants Judging
1 PM Awards Presentation

Presented by the **SANTA CLARITA SUNRISE ROTARY CLUB**
Proceeds To Benefit Santa Clarita Valley Charities

For Information call: (818) 773-1255

Meet New Member...

Seth MacArthur and his wife Beth
1012 Hillcroft Rd., Glendale
(818) 242-8689
1948 Ford Sedan Coupe

Also, please note...Change of address
Jim Winnett: 3777 Township Ave., Simi Valley, CA 93603-1050
(805) 522-3377



"The difference between genius and stupidity is that genius has its limits."

Unknown

SUPPORT OUR ADVERTISERS!

BEV DUPRÉE

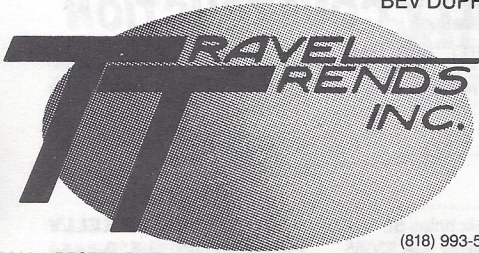

8902½ RESEDA BLVD.
NORTHRIDGE, CA 91324

(818) 993-5400
FAX (818) 993-3972
HOME (818) 883-2747



FLIP SMITH

7735 Sepulveda Blvd.
Van Nuys, CA 91405
(818) 786-8686

Formerly
GLOBE TIRE

DON'S Auto Parts

MACHINE SHOP and BALANCING

Domestic &
Foreign

Parts & Supplies



Monday thru Friday 8 a.m. to 7 p.m.
Saturday 9 to 6 - Sunday 10 to 4

(818)
894-6441

10241 Woodley (At Devonshire)

Sepulveda, CA 91343

RAFFLE PRIZE DONOR

JAMES R. GARY & Co. Ltd.

REALTORS® & ESTATE AGENTS

DON ROSS, CREA

CERTIFIED REAL ESTATE APPRAISER
REALTOR-ASSOCIATE®

21747 Erwin Street
Woodland Hills, CA 91367-3699

Bus: (818) 703-6100
Res: (818) 998-6594
Fax: (818) 703-1870

Older Cars
A Specialty

4 x 4's and
Motorhomes

Russell Sylvis, Inc.

Transmissions
Repaired • Rebuilt

4657 Barnard St.
Simi Valley, CA

(805) 527-4387

R.C. Smith's Roofing Solutions

Roofing & Waterproofing • Complete Maintenance Service

8707-D Lindley Ave., Ste. 199, Northridge, CA 91325
Lic. #356650 (818) 718-2313

Auto • Homeowners

- ANTIQUE CARS -

ED HARDIN INSURANCE

Business • Life • Health • Aircraft



Call us for your Insurance needs!

(818) 363-7864

ALLAN FRANKLIN'S BATTERY TENDER

\$59.99

Club members
\$54.99

Charges battery up and turns itself off
automatically when it fully charged.

Takes the guess work out of battery maintenance!

(818) 842-2230

6, 8, or 12 Volt Models

SUPPORT OUR ADVERTISERS!

L.T. "LEE" SAWYER, INC.

Jobber

Shell Oil and Chemical Products

14117 Aetna Street, Box 369
Van Nuys, California 91408

TOM SAWYER (818) 786-8180 / (818) 785-0902

RAFFLE PRIZE DONOR

KELLY CONSTRUCTION AND ELECTRIC

LIC. # 657087

GENERAL CONTRACTORS

"Remodeling Specialists"

2558 Nicholas St.
Simi Valley, CA 93065

DAVE KELLY
Phone/Fax: (805) 520-6444

SHOE By Jeff MacNelly



SHOE By Jeff MacNelly



PAST PRESIDENTS

JIM ROWE.....	1971
DOUG PETERSON	1972
DON DURKEE	1974
ED WARNOCK	1975
JOHN BUSK.....	1976
CHIP WERSTEIN	1977
STAN MARSRAJE	1978
BOB DRAKE	1979
BILL CULP.....	1979
AL SPENCER.....	1980
LARRY CAPLAN	1981
BOB ROSE	1982
DON DURKEE	1983
PAUL KIRK	1984
KENT LOWRY	1985
DAVE SANBORN.....	1986
JOHN KEMMERER	1987
DUDLEY OCHSNER.....	1988
JERRY JENSEN	1989
JERRY JENSEN	1990
JOE DIFATTA	1991
CHUCK SHUBB.....	1992
CHUCK SHUBB.....	1993

Meetings are held on the first Sunday of every month at 7:00 p.m.

The Valley  **'s**

5920 LEMONA AVE., VAN NUYS, CA 91411

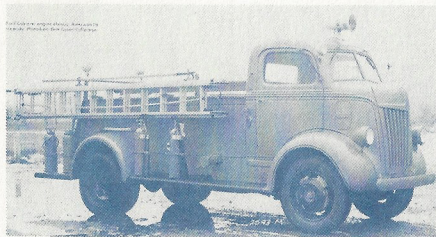
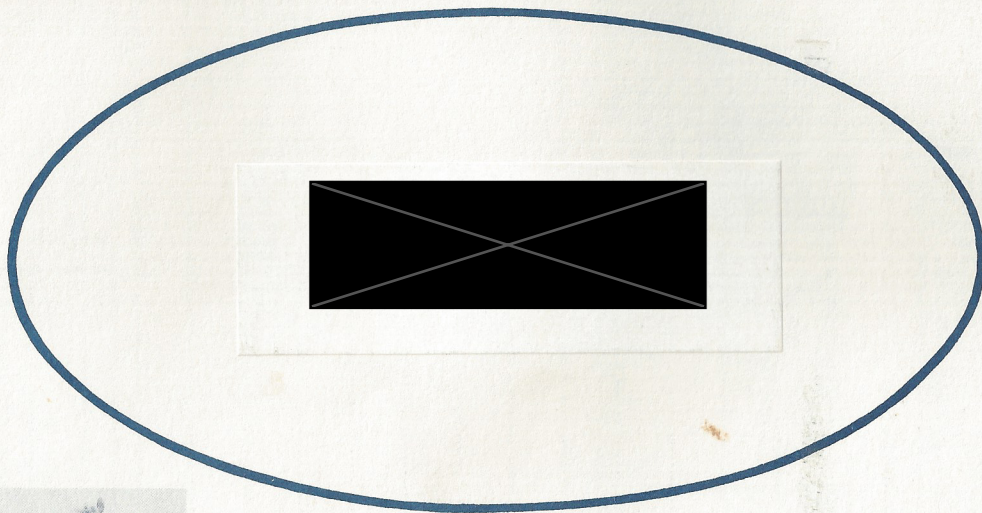
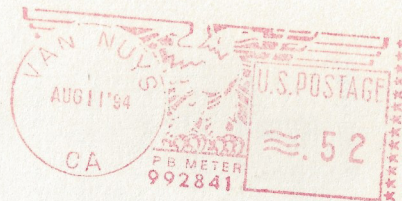

1944 Ford Cab over Fire Truck

