

APRIL

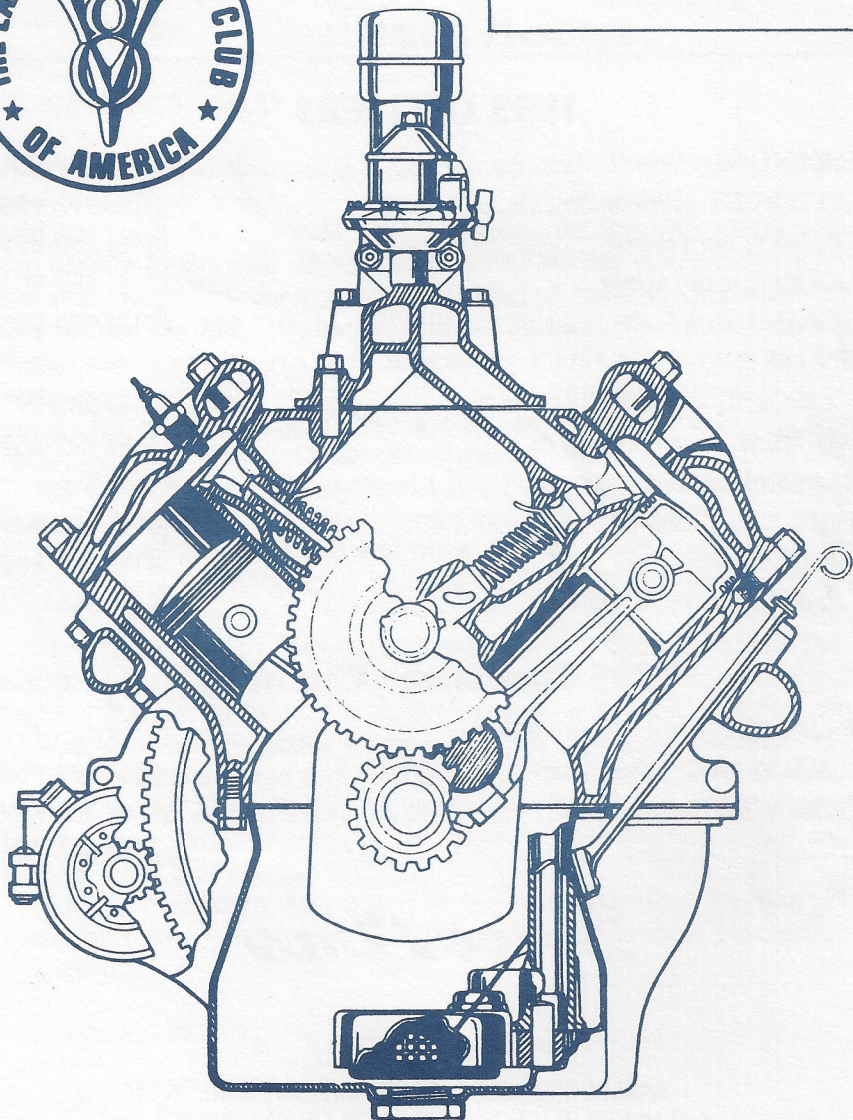

# Drive Lines

# The Valley s

## 1995 OFFICERS

PRESIDENT, Jerry Littner .....	(818) 597-9016
VICE PRESIDENT, Dick Smith .....	(818) 993-9538
SECRETARY, Jim Winnett .....	(818) 768-4228
TREASURER, Lesley Littner.....	(818) 597-9016
PROGRAMS, Dick Smith .....	(818) 993-9538
ACTIVITIES	
ACCESSORIES, Chuck Shubb .....	(818) 882-2927
MEMBERSHIP, George Richards.....	(818) 992-4537
FELLOWSHIP	
RAFFLES, Chuck Mair .....	(818) 785-9413
EDITOR, Miles Schofield .....	(818) 342-8881
TECHNICAL ADVISOR, Don Dupree.....	(818) 883-2747

## 1995 Committee Chairmen

ANNUAL PEPPERMILL, Dudley Ochsner.....	(818) 446-1206
CHRISTMAS PARTY, Dick Smith .....	(818) 993-9538
TEQUILA WILLIE'S, Bob Rose .....	(818) 362-4842
DIRECTORY, Paul Kirk.....	(818) 886-5467

## *Drive Lines*

Published By  
SAN FERNANDO VALLEY CHAPTER 40  
of the EARLY FORD V8 CLUB OF AMERICA  
P.O. Box 96  
Reseda, CA 91335

COVER/ROY JONES

# *The Valley V8's*

APRIL, 1995

## **President's Message**

GREETINGS VALLEY V-8ers:

The annual club auction is coming up and, it's that time of the year again for all you V-8ers to clean up your garages and collect all your junk and get ready for the MAY 7TH AUCTION. Be thinking about what you can donate to the club. This is the only real money raiser that we have for the year. Your donations can be a car part of some sort, or something for the ladies, or ??? The key is that they have to be saleable items. Remember - one man's junk is another man's treasure. Please tag or identify your items so we can make it easier on our auctioneers.

Professor Dupree is having a class on Hydraulic Brake Systems on Saturday, April 15th at 10:30 a.m. It will be held at Don Dupree's house - 23222 Oxnard Street, Woodland Hills. Please R.S.V.P. to Professor Don Dupree (818) 883-2747 or Prez. Jerry Littner (818) 597-9016.

Our April 2nd meeting will have our very own Russ Sylvis as guest speaker. Russ will be talking to us about OVERDRIVE TRANSMISSIONS in 1949-53 cars.

The following is a list I hate to publish but I must. Members that have not paid their dues be aware that this is your last issue of the DRIVE LINES. Please send in your membership renewal so you can continue to receive your club magazine and be a part of a great fellowship.

Members that have not paid dues for 1995: Jim Albert, Patrick Berry, William Boyer, Albie Cortes, Hollis Cotton, Leroy Foster, Bill King, Roger Montgomery, Steve Poulos, John Powell, Thomas Riela, John Sanchez, William Scott and Art Surtees.

I look forward to seeing you at the April meeting. Wishing a Happy Easter and Happy Passover to all. Thanks to Jim Winnett for refreshments this month.

Best regards,

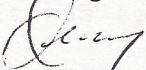

Your Prez. Jerry

CARS & PARTS FOR SALE

Four tires, white walls, 215-70-15, like new...\$160.00. Nino Rosso (213)877-2314.

CARS & PARTS WANTED

Anti-chatter rods for 1940.  
Al Rohrer (818)345-3721

'41 Ford Deluxe Chrome Fender Molding  
for all four fenders. Antique gas pump  
20's and 30's.  
Jack Kelejian (818)996-3744

'41 Ford Horn repair kit  
Carlos Wilhelm (619)249-4312

'37-'40 Ford Columbian, '37-'40 Lincoln  
Columbian.  
Richard Valleroy (310)828-7276

REFRESHMENTS

APRIL - Jim Winnett

SEPTEMBER -

MAY - Dick Smith

OCTOBER -

JUNE - Lin Kemmerer

NOVEMBER -

JULY -

JANUARY '96 -

AUGUST -

As you can see, we need somemore people  
to sign up for bringing the treats....

The best treats could be the ones that  
you bring, but who cares about the best  
we will eat them...it is NOT a contest.

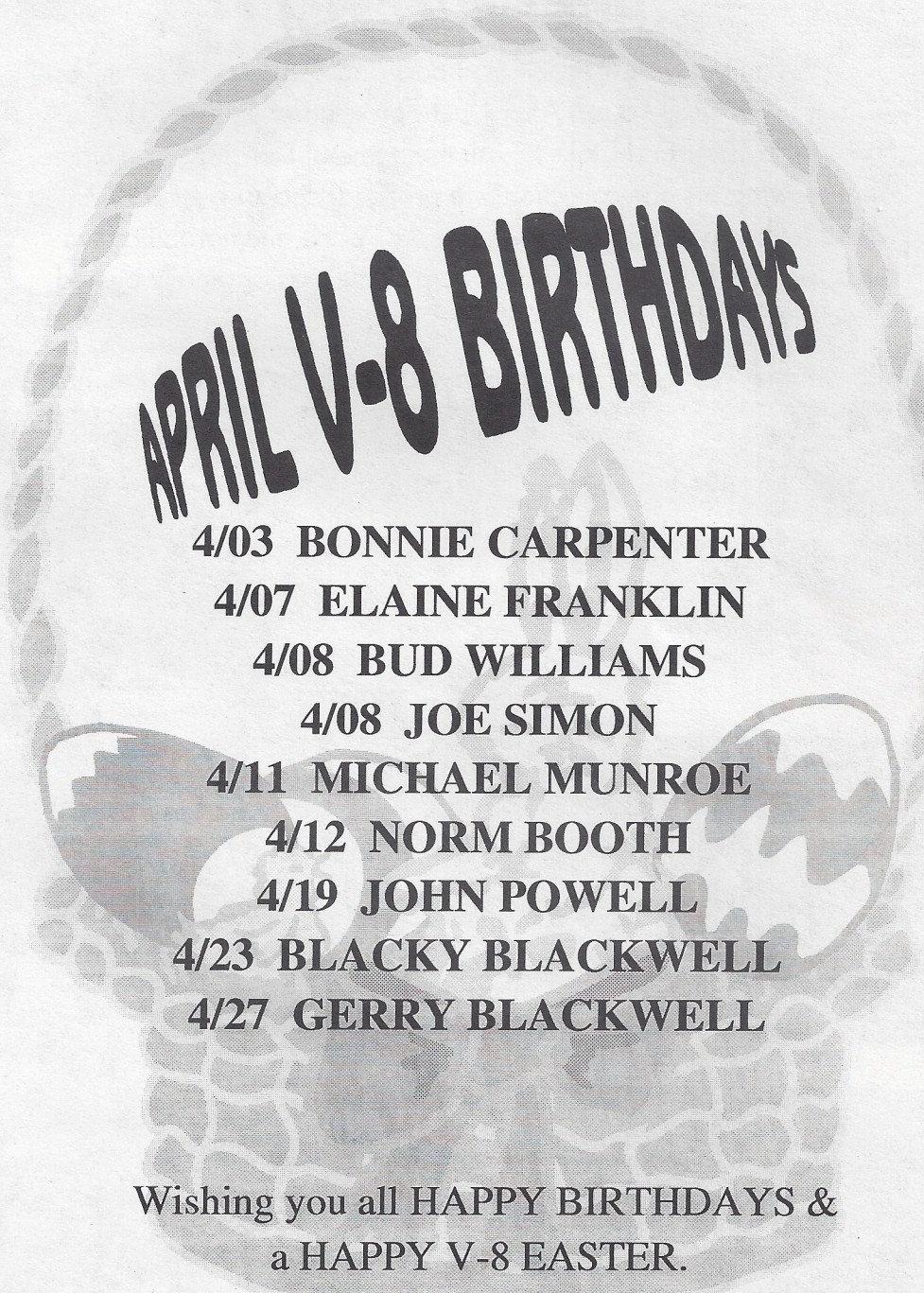

# APRIL V-8 BIRTHDAYS

4/03 BONNIE CARPENTER

4/07 ELAINE FRANKLIN

4/08 BUD WILLIAMS

4/08 JOE SIMON

4/11 MICHAEL MUNROE

4/12 NORM BOOTH

4/19 JOHN POWELL

4/23 BLACKY BLACKWELL

4/27 GERRY BLACKWELL

Wishing you all HAPPY BIRTHDAYS &  
a HAPPY V-8 EASTER.

# Weekday Tour March 8th HUGE SUCCESS!

12 Ford Classics and 24 members and spouses met at Millies Restaurant at 11:00 a.m.. After lunch, proceeded up the 101 Freeway to Thousand Oaks to visit the home of Don & Mary Durkee. After viewing his fine collection, we proceeded to Al Decker's home where he has a big collection of cars, car parts, memorabilia, live birds, parrots & peacocks. This 7 acre home was originally owned by actress Vera Miles.

The weather was great, the group was great, can't wait 'til the next tour.

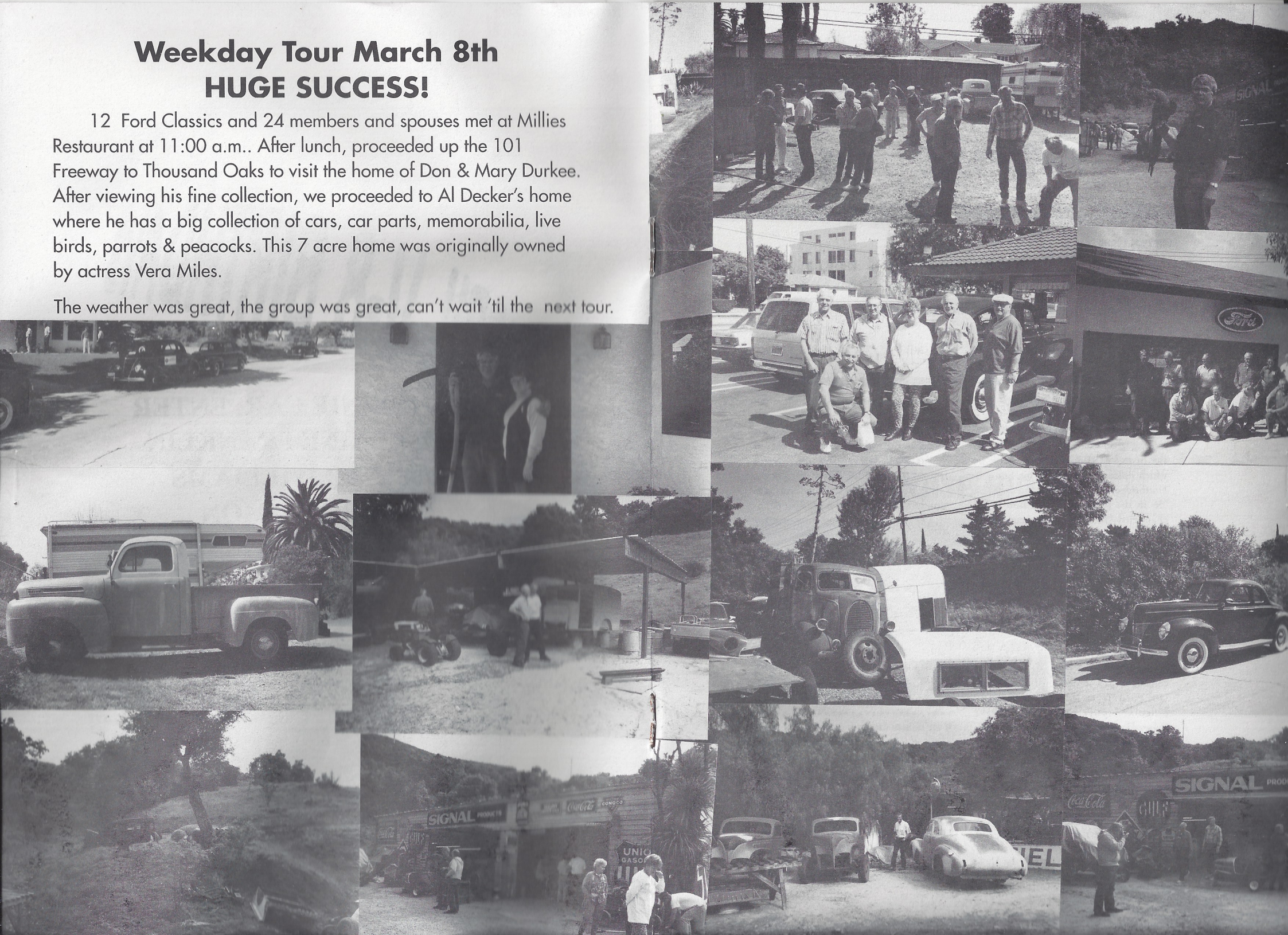



## **F.Y.I.-REFERENCE LIST PART TWO**

### **AUTO CLOCK REPAIR - NON ELECTRIC:**

**HOWARD J. BANTA**

**(818) 349-5305**

### **REPRODUCTION GLASS:**

**SANDERS GLASS**

**P.O. Box 522, Hillsboro, OR. 97123**

**(503) 648-9184**

### **CHEMICAL PAINT & RUST REMOVAL:**

**L & M STRIPPING (GEORGE)**

**14232 Aetna St., Van Nuys, CA. 91401**

**(818) 983-1200**

### **SANDBLASTING:**

**AJAX'S SANDBLASTING SERVICE (BILL OR KEN)**

**7933 Gloria Ave., Van Nuys, CA. 91406**

**(818) 781-5667**

### **APPRAISERS OF COLLECTIBLE AUTOS:**

**HUBBARD & ASSOC. (RALPH A. HUBBARD)**

**320 Glen Summer Rd., Pasadena, CA. 91106**

**(818) 568-0122**

### **STAINLESS TRIM RESTORATION: CORRECTION-PLEASE NOTE:**

**MIKE'S OLD CARS (MIKE APLIN)**

**118 Nevada St., El Segundo, CA. 90245**

**(310) 364-1212**

# SUPPORT OUR ADVERTISERS!

BEV DUPRÉE

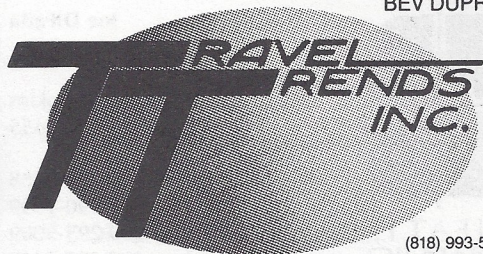

8902½ RESEDA BLVD.  
NORTHRIDGE, CA 91324

(818) 993-5400  
FAX (818) 993-3972  
HOME (818) 883-2747

FLIP SMITH



7735 SEPULVEDA BOULEVARD  
VAN NUYS, CALIFORNIA 91405  
Bus: (818) 786-8686  
Fax: (818) 785-2982

## DON'S Auto Parts

MACHINE SHOP and BALANCING

Monday thru Friday 8 a.m. to 7 p.m.  
Saturday 9 to 6 - Sunday 10 to 4

10241 Woodley (At Devonshire)

Domestic &  
Foreign  
Parts & Supplies



(818)

**894-6441**

Sepulveda, CA 91343

RAFFLE PRIZE DONOR

LESLEY A. LITTNER  
(818) 597-9016 / FAX:597-9145

## BOOKKEEPING & BUSINESS SERVICES

5051 BLACKPOOL AVE.  
AGOURA, CA. 91301



Older Cars  
A Specialty

4 x 4's and  
Motorhomes

Russell Sylvis, Inc.  
Transmissions  
Repaired • Rebuilt

(805) 527-4387

4657 Barnard St.  
Simi Valley, CA

## R.C. Smith's Roofing Solutions

Roofing & Waterproofing • Complete Maintenance Service

8707-D Lindley Ave., Ste. 199, Northridge, CA 91325  
Lic. #356650 (818) 718-2313

Auto • Homeowners

- ANTIQUE CARS -

## ED HARDIN INSURANCE

Business • Life • Health • Aircraft



Call us for your Insurance needs!

**(818) 363-7864**

## ALLAN FRANKLIN'S BATTERY TENDER

**\$59.99**

club members  
\$54.99

Charges battery up and turns itself off  
automatically when it fully charged.

Takes the guess work out of battery maintenance!

(818) 842-2230

6, 8, or 12 Volt Models



# SUPPORT OUR ADVERTISERS!

## L.T. "LEE" SAWYER, INC.

Jobber

Shell Oil and Chemical Products

14117 Aetna Street, Box 369  
Van Nuys, California 91408

TOM SAWYER (818) 786-8180 / (818) 785-0902

RAFFLE PRIZE DONOR

Joe DiFatta



DiFATTA  
GRAPHICS

Incorporated

27642 Avenue Hopkins  
Valencia, California 91355

Phone: 805 295-8788

800 990-1939

Fax: 805 295-5069

Modem: 805 295-5119



(818) 776-3290  
FAX (818) 776-3291

## TERRY Sash & Door

6057 Reseda Boulevard, Tarzana, CA 91356

"Able to service all your Sash & Door needs"

RESIDENTIAL • COMMERCIAL • INVESTMENT



Spencer Realty

3948 Goodland Ave.  
Studio City, CA 91604  
Office: 818-761-1734  
Fax: 818-761-7952



AL SPENCER

QUALITY PROFESSIONAL SERVICE

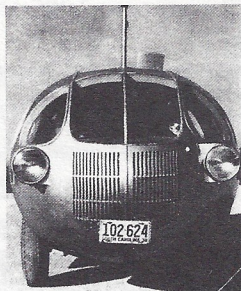
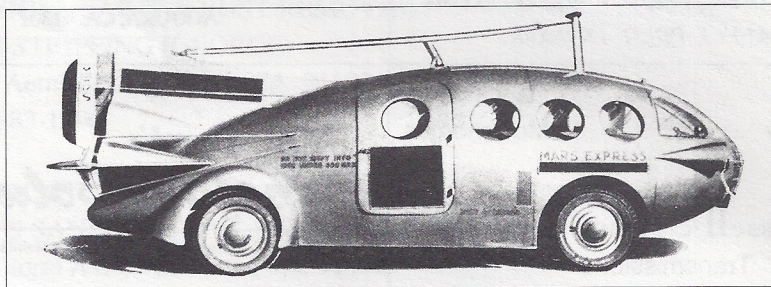

**Whatever Happened to the Mars Express?** This startling and rather attractive bullet car was a real rocket ship, according to its creator, Peter Vacca of Buffalo, New York. Powered by both a supercharged V-8 auto engine and a rocket motor, the idea was to use the car engine to propel the Express up to 115 mph, then cut in the booster rocket for its run to maximum top end. Whether that was ever achieved is not reported, but we hope Mr Vacca changed those bald front tires before the attempt. What we'd really like to know is if this aluminum-bodied one-off has survived the ravages of time. The story

accompanying these photos noted that the car cost \$16,000 to build in 1939 — the price of a very fine house back then! (From February, 1939 Popular Science via Thomas J. Bishop)

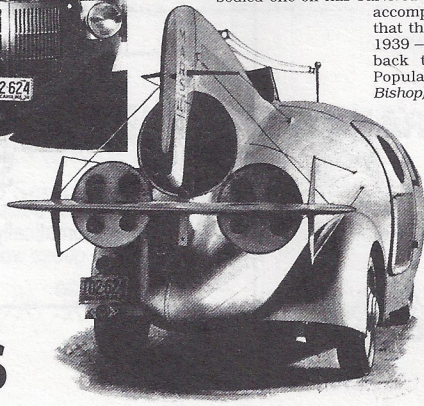

but

oddies

goodies

## PAST PRESIDENTS

JIM ROWE.....	1971
DOUG PETERSON .....	1972
DON DURKEE .....	1974
ED WARNOCK .....	1975
JOHN BUSK.....	1976
CHIP WERSTEIN .....	1977
STAN MARSRAJE.....	1978
BOB DRAKE .....	1979
BILL CULP.....	1979
AL SPENCER.....	1980
LARRY CAPLAN .....	1981
BOB ROSE .....	1982
DON DURKEE .....	1983
PAUL KIRK .....	1984
KENT LOWRY .....	1985
DAVE SANBORN.....	1986
JOHN KEMMERER .....	1987
DUDLEY OCHSNER.....	1988
JERRY JENSEN .....	1989
JERRY JENSEN .....	1990
JOE DIFATTA .....	1991
CHUCK SHUBB.....	1992
CHUCK SHUBB.....	1993
GEORGE RICHARDS .....	1994

**Meetings are held on the first Sunday of every month at 7:00 p.m.**

**The Valley**  **'s**

5051 BLACKPOOL AVE., AGOURA, CA 91301

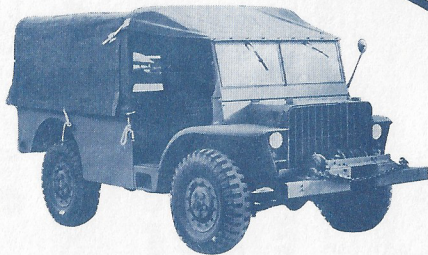
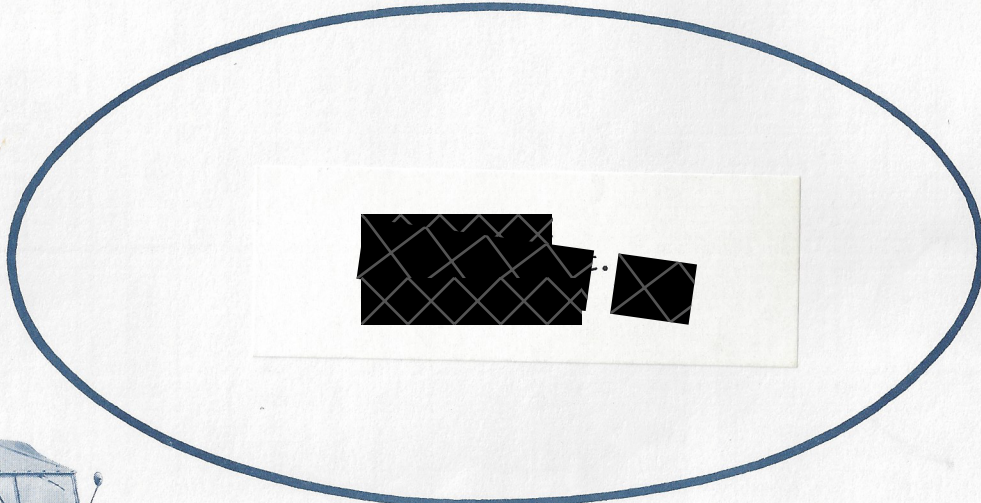

**1945 Ford Cargo Truck**