

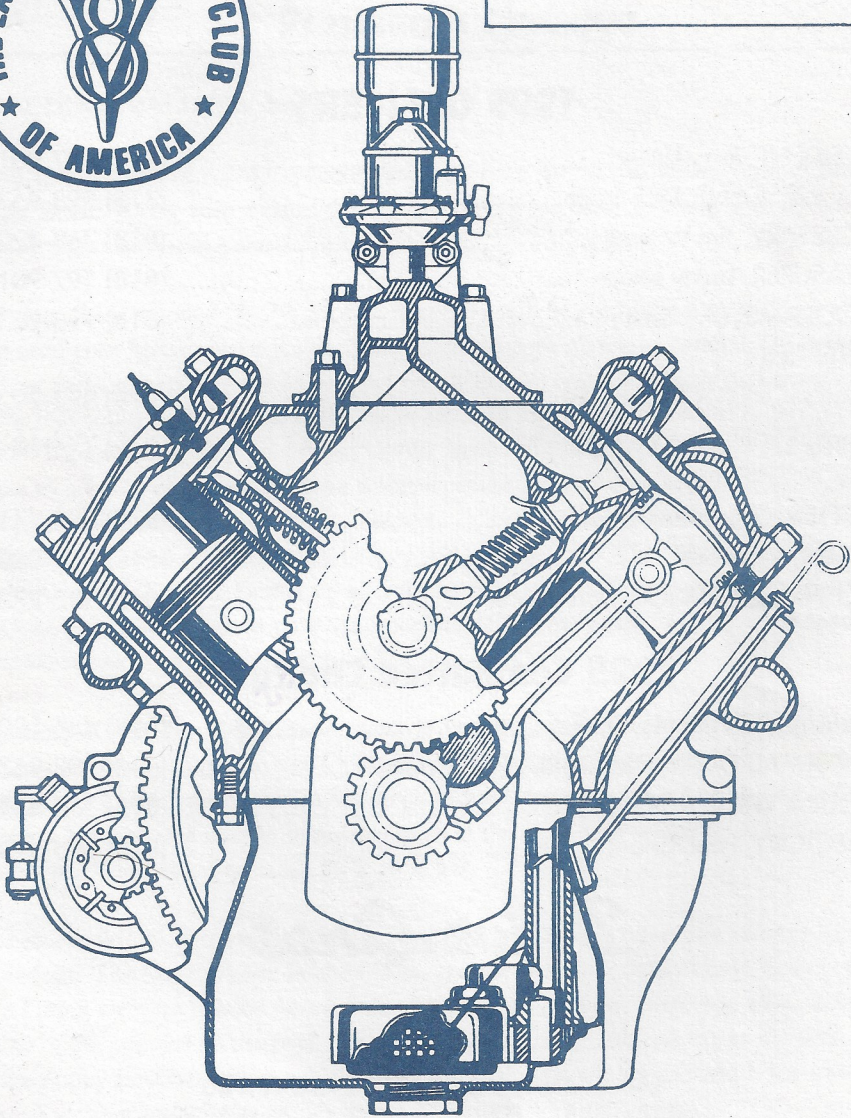

MAY



Drive Lines

The Valley 's

1995 OFFICERS

PRESIDENT, Jerry Littner	(818) 597-9016
VICE PRESIDENT, Dick Smith	(818) 993-9538
SECRETARY, Jim Winnett	(818) 768-4228
TREASURER, Lesley Littner.....	(818) 597-9016
PROGRAMS, Dick Smith	(818) 993-9538
ACTIVITIES	
ACCESSORIES, Chuck Shubb	(818) 882-2927
MEMBERSHIP, George Richards.....	(818) 992-4537
FELLOWSHIP	
RAFFLES, Chuck Mair	(818) 785-9413
EDITOR, Miles Schofield.....	(818) 342-8881
TECHNICAL ADVISOR, Don Dupree.....	(818) 883-2747

1995 Committee Chairmen

ANNUAL PEPPERMILL, Dudley Ochsner.....	(818) 446-1206
CHRISTMAS PARTY, Dick Smith	(818) 993-9538
TEQUILA WILLIE'S, Bob Rose	(818) 362-4842
DIRECTORY, Paul Kirk.....	(818) 886-5467

Drive Lines

Published By

SAN FERNANDO VALLEY CHAPTER 40
of the EARLY FORD V8 CLUB OF AMERICA

P.O. Box 96
Reseda, CA 91335

COVER/ROY JONES

The Valley V8's

MAY, 1995

President's Message

GREETINGS VALLEY V-8ers:

Well, this last part of April has finally brought some spring-like weather to our little corner of the world. Along with it came thoughts of driving old cars, meeting with friends on warm Friday nights and, our Annual Spring Auction.

As you all know, our May 7th auction hopefully will be our biggest fund-raiser of the year. We need your help to make it a success. Here are your marching orders: (1) Bring as many old car parts and accessories as you can part with. (2) Have your lady gather up saleable items that could be of interest to the fairer sex... or maybe even to some of us tough-guys. (3) Perhaps some of you 'chef-types' could bake something. (4) Look in the garage first. Then look in the closet for all those white elephants you've received from Aunt Louise over the years and just couldn't display. These have just become very valuable items for our auction. You must remember that beauty and necessity are in the eyes of the beholder, or something like that. (5) Gather up all your auction-goodies and be present on Sunday, May 7th with your checkbook in your back-pocket. (I've heard there will be some special home-made treats for us to munch on.)

For those of you who didn't read it in the National magazine, our very own Dave Sanborn has just accepted the position of Chairman of the Judging Standards Committee. Best of luck Dave. Our fellow V-8er Ed Warnock recently stepped-down from his Chief Judge position because of a change in management at the airline for which he is a pilot. Our best wishes to Ed and sincere thanks for a great job.

Our recent Wildflower tour in the hills near Lancaster was a blooming success (pun intended). The flowers were in abundance and the weather couldn't have been better. In fact I think we even missed the crowds - because the next day there was a beautiful color photo of the poppies on the front page of the L.A. Times. Advertising at it's best. We hiked in the Poppy Reserve until lunch-time then headed over to Lake Elizabeth for some food, duck-watching and wind-surfers. It was a great day!

Looking forward to more old-car fun days ahead.

Best regards,

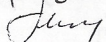

Your Prez. Jerry

Program for May 7th, 1995 at
GLENDALE FEDERAL SAVINGS
21821 DEVONSHIRE, CHATSWORTH

TIRE KICKING: 7:00 P.M.

MEETING: 7:30 P.M.

Jim Winnett's

SECRETARY'S VIEWPOINT

Meeting #4 of 1995 and the first day of Daylight Savings Time was one of our better turnouts. I do not know if it was the weather and/or that Russ Sylvis was our speaker and for the evening that brought out the Valley V-8ers and their Early V-8 FORDs and the other pride & joys that were driven.

Chuck Shubb brought two guests - Bob and Tom Thornton. Carlos Wilhelm brought Belinda Machorro. And Blake Winnett was there selling his sister's Girl Scout cookies and his Boy Scout candies.

The name drawn for the "Name Badge" drawing was Bud Williams. This Bud, was for you \$20.00. But since you were NOT at the meeting, the "Name Badge" pot grows...

During our raffle, President Jerry Littner was caught trying to take Chuck Shubb's, already acquired, raffle choice.

Our own Valley V-8er, Russ Sylvis was our speaker this evening. Russ talked about transmissions and he gave us a "Trade Secret", which requires one to travel about 40 mph and put an automatic transmission in Park. Do NOT try this at home without consulting Russ for the correct procedure.

Russ, also, informed us, among other things, that transmissions with overdrives have a separate fluid filling access for the transmission and overdrive unit. You need to fill BOTH to the proper levels. Russ had a lot more information that you needed to be there for.

All of the "Mothers" have a wonderful Mother's Day and everyone have a great Memorial Day weekend!

Respectfully,
Jim Winnett

EARLY V-8 FORDS DRIVEN

- '35 FORD 3 window - Allan Franklin
'39 Convertible - Drek Chutuk
'39 Deluxe Tudor - Jerry Jensen
'40 FORD Coupe - Lin Kemmerer
'40 FORD Coupe - John & Virginia Wolf
'41 FORD Convertible - Bob Rose
'48 FORD Coupe - Joe DiFatta
'48 FORD Coupe = Joe's - Dick Smith
'48 Lincoln - Bob Thornton
'53 FORD Coupe - Lloyd & Donna Paschal
'53 Mercury 2 door - Don Durkee

Ken Sapper drove his '27 Track T,
Don Dupree drove his '65 Lincoln Convertible,
and Marty Luening drove his '50 Plymouth....

REFRESHMENTS

MAY	- Dick Smith	SEPTEMBER	-
JUNE	- Lin Kemmerer	OCTOBER	-
JULY	- Donna Paschal	NOVEMBER	-
AUGUST	- Chuck Shubb	JANUARY '96	-

As you can see, we need JUST FOUR more people to sign up to bring in some treats.

If I can do it, then any one can....

Thank you to those of you that have signed up and thanks to those who have already brought treats, in the past few months!!

CARS & PARTS FOR SALE

ITEM

Name / Phone

'36 5 Window FORD - \$6,000

Larry Ready
(818) 886-3660

'35 FORD 4 dr. Conv. Tan color, Red
Spoke wheels - Extra set of Kelsey Hayes Wheels
Restored \$23,000

Joe Bellomo
(805) 522-0445

'41 Steering Wheel

Carlos Wilhelm
(619) 249-4312

'54 FORD 1/2 ton P.U. - \$3,500

Don Durkee
(805) 495-5298

'63 1/2 FORD 2 Dr. H.T.
- original one owner \$3,000

Bob Zecker
(818) 352-3311

16" Wire Wheel 1935 (5 w/tires) \$100

Allan Franklin
(818) 842-2230

'37 - 40 FORD Columbian,
'37 - 40 Lincoln Columbian

Richard Valleroy
(310) 828-7276

CARS & PARTS WANTED

ITEM

Name / Phone

'41 FORD Dash dimmer switch

Carlos Wilhelm
(619) 249-4312

'40 FORD Convertible Top Irons

Richard Valleroy
(310) 828-7276

JACKPOT

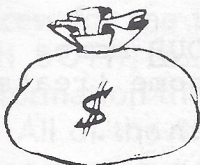

\$20.00

Could Be Yours!

(You just have to be present and wear your name badge to win.)

MAY V-8 BIRTHDAYS

5/06 MARY LOMBARDO

5/09 HAROLD SELSEN

5/09 PENNY SURTEES

5/09 DOUG PETERSON

5/11 VIRGINIA WOLF

5/12 BEN OSTERGREN

5/15 SETH MacARTHUR

5/19 PAUL KIRK

5/20 ANN POWELL

5/26 CRAIG LAPAIR

5/28 EMILY ROSSO

5/30 DUDLEY OCHSNER

5/30 JUDY SHUBB



Blossomless Tour

By David Sanborn

Gerry Blackwell did it again. She led us on a fabulous tour March 18 and 19. The tour advertised seeing fruit tree blossoms on The Fresno County Blossom Trail. Nary a blossom was to be found, but nobody cared. Jerry packed the tour with so many fun activities that we had no time to miss the absent blossoms.

At least 10 but maybe 25 real cars (real cars being Early Ford V-8's) and a few modern boxes gathered in Castaic for breakfast. At the start Jerry furnished us with burlap bags filled with goodies. She included a hand colored tour itinerary. Class all the way.

We toured over the Grapevine making regular relaxing rest stops. Jerry spread hot coffee and freshly baked muffins on a linen tablecloth somewhere south of Fresno called Travers. Life felt so great we didn't care where we were.

Just east of Fresno the Blossomless portion of the tour

began. We traveled past manicured almonds, plum, apple, apricot, peach and citrus orchards. The brilliant green new leaves glistened under overcast skies.

One person later marveled at the bright orange blossoms he saw on some trees. He said they looked full and round about the size of an orange. Someone else pointed out that they were oranges.

We feasted on lunch at Whispering Waters Lake. Fisherpeople pulled large trout and catfish from the lake. We took lots of pictures and fed leftovers to the friendly ducks and nasty geese.

Then onward past more blossomless trees to The Minkler Cash Store. This store looked built before the White man invaded this country. It is old. It also is packed with turn of the century display items.

Across the street Country Crafts had just that - great chachkas for every non-need. Gerry investigated it thoroughly to get ideas for the country store she plans in Agua Dulce.

From Minkler the Blossom Trail rose into the Sierra Nevada foothills. Wild flowers redeemed the trail's name. Varieties of blue lupine, a few California poppies, yellow mustard and white daisies patched the hills and dales with color.

We circled back into the valley floor to Reedley. The Edgewater Inn served us well as our stop for the night. It sits comfortably beside the Kings Rivers.

Reedley bills itself as "The World's Fruit Basket." During the picking season, which lasts several months, over 200 semitruck loads of fresh fruit leave Reedley daily on a specially built four lane highway.

After some of us took a short nap and others did whatever in private we started an eventful evening in downtown Reedley.

We gathered at the Reedley Opera House. It is an immaculately restored building listed on the National Register of Historic Places. Jesse Jansen, a Danish Sea Captain, built the Opera House in 1903.

After gathering, we walked around the corner to the Mennonite Quilt Center. The Mennonites settled in Reedley before the turn of the century because of its rich fertile soil. Today they continue their tradition of helping others. One of their important fund raisers is making and selling quilts.

Oh what fabulous quilts. The Mennonite 28th Annual West Coast Sale and Auction for World Relief is being held at Fresno Pacific College April 7-8. We benefited by getting to preview many of the quilts gathered for the auction.

To give you a concept of their desirability, quilts sell for up to \$9,000 each. That works out to as much as \$1 per hour for the volunteer quilters time. I'm awed by the product of the Mennonite's labor of love. We left generous contributions for their hospitality.

Next we went back to the Opera House for dinner served with fine china, silver and crystal. I expected a traditional rubber chicken banquet dinner. How wrong I was. The chicken fillets and beef roast with fresh snow peas and stuffed potato equaled

most five star meals I've eaten in France.

A pianist played through dinner. Then a barbershop quartet sang to us and led a singalong. As a finale the pianist and her husband sang some duets. A delightful evening.

Pat Berthold, our Reedley historian and tour guide, reserved a room for breakfast at the local restaurant. We gathered there Sunday morning. I loved the food, especially the fresh strawberries.

Pat took us back downtown Reedley where we toured the Reedley Museum. The building served as Reedley's first city hall, police and fire department and jail soon after the City's incorporation in 1913. Today the museum houses rooms for a turn of the century display, Native Indian artifacts, ethnic group heritage and culture displays and early settlers tools and equipment. We again left generous contributions.

Next we stopped at Simonian Farms. They grow and direct market over 90 varieties of fruits and vegetables. The

perimeter of the store and parking area is circled by renovated farm tractors and implements.

Inside the market old mannequins, porcelain signs, antique bicycles and restored vintage gas pumps accent the fresh produce and nuts.

Blacky fell in love with a restored Wayne Model 60 gas pump. It took Gerry 30 minutes to disengage Blacky so we could start home.

Most of us stopped at The Superior Dairy and Ice Cream Parlor in Hanford, about 20 miles south of Simonian Farms. We toured the Hanford town square and an extensive antique mall then headed south. After a six-hour trip, which normally takes three, shepherding Jerry and Lesley Littner's 37 Ford V-8 60 Coupe, we arrived home happy and very tired.

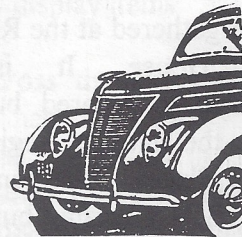

HYDRAULIC BRAKE CLASS

If you didn't see the announcement of Don Dupree's class on hydraulic brake systems in the April President's Message, you missed a good and informative time. The ones who attended were, shall we say, a select group. And the weather cooperated so much that Professor Dupree held the class on the back porch of his house in bright sunshine. In fact, it was so warm that we soon retreated to the shade of the patio cover for donuts, lemonade, and coffee.

The class covered flathead hydraulic brakes, including wheel cylinders, master cylinders, and how to clean them up. The Professor also explained the difference between slotted and eccentric anchors and how to adjust them for maximum shoe contact with the drum. We even got into master cylinder pushrod adjustments and how to check for freeplay in the pedal. It was a good class, and reminded those of us who have worked with those Ford brakes for years that there are things we had forgotten.



THE VENTURA V-8 CLUB CORDIALLY INVITES THE VALLEY V-8 CLUB
TO JOIN THEM FOR:
THE LAGUNA BEACH PAGENT OF THE MASTERS
SUNDAY, JULY 16TH

This is a day of art, entertainment and friendship.

A bus will take us all there so the party begins right away. There will be pick-ups for Valley people. The approximate cost is \$40. per person for the bus and ticket to the show. Meal and goodies on you own.

If you are interested please contact Gerry Blackwell by MAY 5TH. (805) 268-0040.

If you've never seen this event... don't let it get by you.

Call Gerry now & ask her for the details.

ANOTHER VENTURA V-8 TOUR: JOIN THE FUN
SATURDAY, MAY 13TH

DESCANSO GARDENS TOUR

Join the Ventura Club for a great tour of the beautiful Descanso Gardens in the La Canada/Flintridge area of the Valley.

Meet at Woodley Park at 9:15 a.m. We will be leaving promptly at 9:30.

We will have lunch at the Gardens and there will be some time for antique explorations, etc.

Contact Gerry Blackwell for further information.

EVENTS - MAY & JUNE, 1995

- MAY 6 & 7 - Wold Classic Auction, Newport Beach - Hyatt Newporter (510) 736-0695
- MAY 7 - Vintage Limited Steet Rods; Bakersfield (805) 834-4001 / (805) 872-0748 (eve.)
- MAY 7 - Cobra Owner's Club of America "open track" at Willow Springs
- MAY 7 - Regents Car Show III; La Reina High School, Thousand Oaks (805) 386-4352/492-9321
- MAY 7 - Classic Chevys of So. Cal. at Cruiser's Car Wash, Northridge 886-2463/999-9414 (eve)
- MAY 13 - Descanso Gardens Tour with Ventura V-8 Club (Gerry Blackwell) (805) 268-0040
- MAY 14 - Long Beach Swap Meet, Veterans Stadium (800)762-9785
- MAY 21 - Early Ford V-8 club, Big Valley R.G., All Ford Picnic, Oak Grove Park near Stockton (209) 836-2783
- MAY 28 - Toy Car Swapmeet in Buena Park (310) 832-2282
- MAY 29 - Canoga Park Memorial Day Parade (818) 991-6937
- JUNE 4 - Pomona Swap Meet at Fairplex (714) 832-2041/544-7004
- JUNE 11 - Long Beach Swap Meet at Veterans Stadium (800) 762-9755
- JUNE 17 & 18 - L.A. Roadsters Show/Swap Meet at Fairplex, Pomona (818) 768-2255
- JUNE 25 - Le Cercle/ City of Hope Concours d'Elegance in L.A. (310) 273-1177
- JULY 16 - Pagents of the Masters with the Ventura V-8 Club (Gerry Blackwell) (805) 268-0040

IT'S ONLY 90 DAYS UNTIL THE FABULOUS 'HARRIS' TOUR DEPARTS FOR THE WESTERN NATIONAL MEET IN BEND, OREGON. ARE YOU COMING WITH US ??

Following is a list of the hotels we'll be staying at, and the dates:

<u>DATE</u>	<u>HOTEL</u>
Tuesday, August 15th	Best Western Greentree Inn, San Simeon 805-927-4691 800-528-1234
Wednesday, August 16th	Best Western Monterey Inn, Monterey 408-373-5345 800-528-1234
Thursday, August 17th	Holiday Inn of Fairfield, Fairfield, Ca. 707-422-4111 800-HOLIDAY
Friday, August 18th	Harringtons Sierra Pines Motel Sierra City 916-862-1151
Saturday, August 19th	Charm Motel, Burney, CA. 916-335-2254
Sunday, August 20th	Crater Lake Lodge, Crater Lake, Or. 503-830-8700

The tour will depart from Woodland Hills on Tuesday morning, August 15th, from the Vagabond Inn at 20157 Ventura Blvd (Winnetka offramp). If you plan on staying overnight the night before you can make your reservations at the Vagabond by calling 818-347-8080.

The basic tour route this year will take us up Hiway 1 to San Simeon, the Carmel-Monterey area, then up thru Seaside and some antique stops, then inland to Benicia (great historic town), San Jose, Fairfield-Suisun area, Grass Valley, up Hiway 49 to Lassen Volcanic National Park, then on to Weed, Klamath Falls, Oregon, Crater Lake, and then on into Bend by noon Monday to enjoy the start of the meet. Many interesting stops are set, and others are still in the planning stage. Some of them include a stop on scenic Hiway 1 at a service station-restaurant area where the owner is going to rope off a special area for the V-8s so we can sightsee and display our cars at the same time. You won't believe the view! Our lunch stop that day will be equally as beautiful, with an informal lunch in a patio area overlooking the ocean with whitewater a cliffs below. Several stops are planned which include antiquing/exploring of historic old towns. In Sacramento we'll stop at the Towe Automotive Museum and the State capital. A fantastic waterfall awaits us at Burney Falls State Park, and then the grandeur of Lassen Volcanic National Park, followed by a visit to Klamath Falls, Oregon, and a stop for the night at the newly renovated Crater Lake Lodge. The final morning we will tour the gorgeous Rim Drive around Crater Lake before driving on into Bend.

That's it!! For those of you who have taken a similar route with me before and feel that you've 'seen it all before', forget it! We'll be doing different things, stopping at different places - it'll be a new experience.

IMPORTANT. IF YOU'RE PLANNING TO JOIN US ON THE TOUR, PLEASE RSVP TO ME AT 619-728-0311 IF YOU HAVEN'T ALREADY. THERE ARE CERTAIN LOCATIONS WHICH REQUIRE ME TO PROVIDE A 'HEAD COUNT' WELL IN ADVANCE. ALSO, A TOUR BOOKLET WILL BE PREPARED IN YOUR NAME AND MAILED TO YOU.

JAY HARRIS

YOU ARE INVITED

COASTAL VALLEYS C.H.V.A. HAS ARRANGED A TOUR

SATURDAY MAY 13, 1995

WE WILL BE TOURING

HOLLYWOOD PICTURE CARS

THERE IS NO CHARGE FOR THIS TOUR BUT DUE TO LIMITED SPACE, RESERVATIONS ARE NECESSARY

WE WILL MEET AT WOODLEY PARK AT 10:00 A.M.
AND TOUR FROM
THERE TO THE SITE.

IF YOU WOULD LIKE TO SEE MANY 30'S 40'S AND 50'S
MOVIE CARS THIS IS THE TOUR FOR YOU.

FOR RESERVATIONS

CALL CHUCK SHUBB (818) 882-2927

"ODE TO A DEVOTED STOCKPILER"

Over 30 years ago -
and then some
I met this guy
Oh! He was handsome.
Pounding the keys
and having fun
I believe my life
had just begun.
This crazy guy was
bright and wacky
And also wanted to be
known as "Blacky".

The Fire Dept. gave him time
to drive those streets
not knowing what he'd find.
The "Model T" was first in line
and then came "Moreland"
right behind.

The "Jordan" next -
we scratched our heads
Had Blacky lost his mind ?
They said.

Then one day he saw
the light.
His first
V-8 came into sight
He started with a "'40 Woody"
The old man said, "Blacky it's
a goody."
Along the V-8 trail
he plundered
That Woody was cute, but
quite encumbered.
Someone saw that glint
in his eyes
Along came the "coupe"
and Blacky, he buys !
So he bought this beauty
it came in a box
Brought it home to his family

like bagels and lox.
His son said "Hey Dad where
are you putting this junk?"
He said, "Bob, now don't you worry,
upstairs near your bunk."

Now the fever has caught him
What a frenzy he's in.
The next "convertible"
all dirty as sin.
His daughter said, "Oh Dad, I
just love this car, can
I have it, oh please, I won't drive it far !"
He said, "Not on you life, this
one's the best. We'll make it
a show car it can sit
with the rest."

The fever is burning
to swap meets he goes
All over the country,
his buddies in tow.
His family is left
to carry the burden
While his head's in a
junk pile, maybe in Vernon.

A "'36 Roadster" is next
in the bunch
Then along comes a "delivery"
Before our next lunch.
A "pick-up", a "fire engine"
What next do I ask ?
He says, "Don't you worry
Then all can be made cash !"

Yea, right ! I remark as
I watch him each day
Stroke those fenders so
lovingly - oops!
I forgot the "A".

In a chicken coop somewhere
I have never seen it.
Sits a "29 Stake Bed"
It must be quite scenic.

Now life is unwinding
All toiling is through
He spends most of his time
With his fat-fendered few.

His building erected
His collections in tact
He's even got time
for an occasional chat.

These years have been fun
The hobby is great
I can usually guess where
He is when he's late.
He's probably at Larry's
or maybe with Don or
could be a new friend
...he has to bond.

So I sit here with patience
cause I know in the end
Wherever he is, He's made
some new friends.

By: Gerry Blackwell

SUPPORT OUR ADVERTISERS!

L.T. "LEE" SAWYER, INC.

Jobber
Shell Oil and Chemical Products

14117 Aetna Street, Box 369
Van Nuys, California 91408

TOM SAWYER (818) 786-8180 / (818) 785-0902

RAFFLE PRIZE DONOR

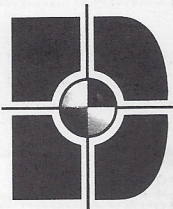

**DiFATTA
GRAPHICS**
Incorporated

Joe DiFatta

27642 Avenue Hopkins
Valencia, California 91355

Phone: 805 295-8788
800 990-1939

Fax: 805 295-5069
Modem: 805 295-5119



TERRY Sash & Door

6057 Reseda Boulevard, Tarzana, CA 91356

"Able to service all your Sash & Door needs"

(818) 776-3290
FAX (818) 776-3291

RESIDENTIAL • COMMERCIAL • INVESTMENT



Spencer Realty

3948 Goodland Ave.
Studio City, CA 91604
Office: 818-761-1734
Fax: 818-761-7952



AL SPENCER

QUALITY PROFESSIONAL SERVICE

SUPPORT OUR ADVERTISERS!

BEV DUPRÉE

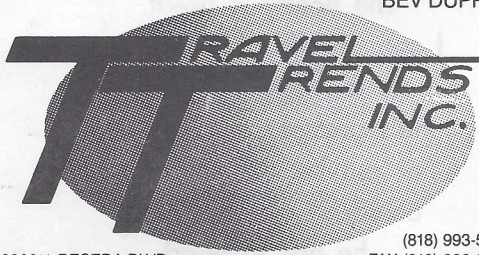

8902½ RESEDA BLVD.
NORTHRIDGE, CA 91324

(818) 993-5400
FAX (818) 993-3972
HOME (818) 883-2747

FLIP SMITH



7735 SEPULVEDA BOULEVARD
VAN NUYS, CALIFORNIA 91405

Bus: (818) 786-8686
Fax: (818) 785-2982

DON'S Auto Parts

MACHINE SHOP and BALANCING

Monday thru Friday 8 a.m. to 7 p.m.
Saturday 9 to 6 - Sunday 10 to 4

10241 Woodley (At Devonshire)

Domestic &
Foreign

Parts & Supplies



(818)

894-6441

Sepulveda, CA 91343

RAFFLE PRIZE DONOR

LESLEY A. LITTNER

(818) 597-9016 / FAX:597-9145

BOOKKEEPING & BUSINESS SERVICES

5051 BLACKPOOL AVE.
AGOURA, CA. 91301



Older Cars
A Specialty

4 x 4's and
Motorhomes

Russell Sylvis, Inc.

Transmissions
Repaired • Rebuilt

(805) 527-4387

4657 Barnard St.
Simi Valley, CA

R.C. Smith's Roofing Solutions

Roofing & Waterproofing • Complete Maintenance Service

8707-D Lindley Ave., Ste. 199, Northridge, CA 91325
Lic. #356650 (818) 718-2313

Auto • Homeowners

- ANTIQUE CARS -

ED HARDIN INSURANCE

Business • Life • Health • Aircraft



Call us for your Insurance needs!

(818) 363-7864

ALLAN FRANKLIN'S BATTERY TENDER

\$59.99

club members
\$54.99

Charges battery up and turns itself off
automatically when it fully charged.

Takes the guess work out of battery maintenance!

(818) 842-2230

6, 8, or 12 Volt Model

PAST PRESIDENTS

JIM ROWE.....	1971
DOUG PETERSON	1972
DON DURKEE	1974
ED WARNOCK	1975
JOHN BUSK.....	1976
CHIP WERSTEIN	1977
STAN MARSRAJE.....	1978
BOB DRAKE	1979
BILL CULP.....	1979
AL SPENCER.....	1980
LARRY CAPLAN	1981
BOB ROSE	1982
DON DURKEE	1983
PAUL KIRK	1984
KENT LOWRY	1985
DAVE SANBORN.....	1986
JOHN KEMMERER	1987
DUDLEY OCHSNER.....	1988
JERRY JENSEN	1989
JERRY JENSEN	1990
JOE DiFATTA	1991
CHUCK SHUBB.....	1992
CHUCK SHUBB.....	1993
GEORGE RICHARDS	1994

Meetings are held on the first Sunday of every month at 7:00 p.m.

The Valley's



5051 BLACKPOOL AVE., AGOURA, CA 91301

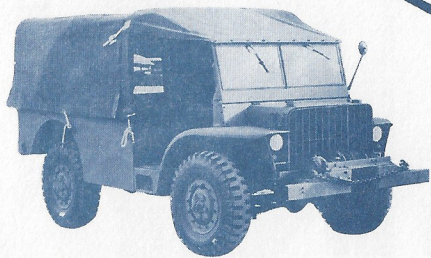
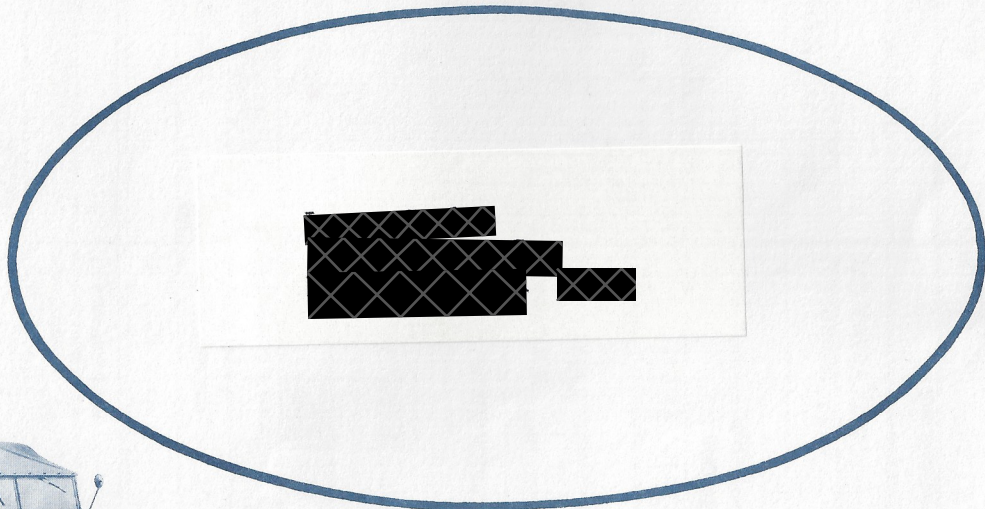
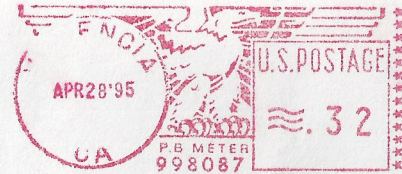

1945 Ford Cargo Truck