

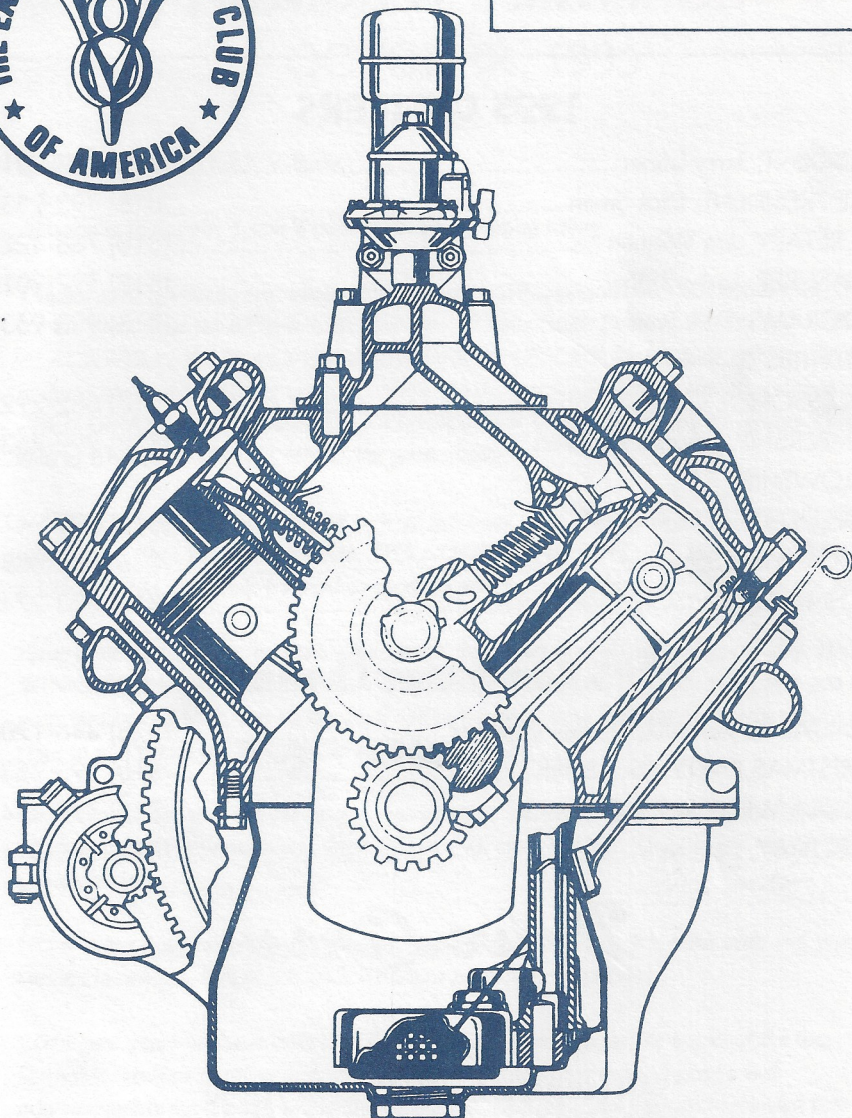

OCTOBER



Drive Lines

The Valley 's

1995 OFFICERS

PRESIDENT, Jerry Littner	(818) 597-9016
VICE PRESIDENT, Dick Smith	(818) 993-9538
SECRETARY, Jim Winnett	(818) 768-4228
TREASURER, Lesley Littner.....	(818) 597-9016
PROGRAMS, Dick Smith	(818) 993-9538
ACTIVITIES	
ACCESSORIES, Chuck Shubb	(818) 882-2927
MEMBERSHIP, George Richards.....	(818) 992-4537
FELLOWSHIP	
RAFFLES, Chuck Mair	(818) 785-9413
EDITOR, Miles Schofield	(818) 342-8881
TECHNICAL ADVISOR, Don Dupree.....	(818) 883-2747

1995 Committee Chairmen

ANNUAL PEPPERMILL, Dudley Ochsner.....	(818) 446-1206
CHRISTMAS PARTY, Dick Smith	(818) 993-9538
TEQUILA WILLIE'S, Bob Rose	(818) 362-4842
DIRECTORY, Paul Kirk.....	(818) 886-5467

Drive Lines

Published By

SAN FERNANDO VALLEY CHAPTER 40
of the EARLY FORD V8 CLUB OF AMERICA

P.O. Box 96
Reseda, CA 91335

COVER/ROY JONES

The Valley V8's

PRESIDENT'S MESSAGE

OCTOBER, 1995

GREETINGS VALLEY V-8ers:

Autumn is in the air. I saw it peek through the smog today.

Thanks must go out to our wonderful and devoted Peppermill host, DUDLEY OCHSNER for the great time we all had at the 10th annual Peppermill Brunch. Thanks also to GERRY BLACKWELL, JULIE OCHSNER and my wife, LESLEY for all their efforts. While I'm in the business of thanking people... thanks to the guest speakers at our September meeting - BEN DiFATTA and WHITNEY RYDBECK for 2 very interesting programs. Thanks also to BLACKY BLACKWELL for great cookies.

A Valley V-8 WELCOME to our newest members : RICHARD & VELVET HELLER who own a 1941 Ford Convertible. WELCOME also to :JOEL SHUKOVSKY who owns a 1950 F1 P/U. We look forward to meeting you and checking out those hunks of steel.

Happy and sad news to report ! Our trusted Secretary and all-around good-guy, JIM WINNETT is leaving the state for a "better life" in Oregon. We sure will miss you and your family and wish you all the best! Which brings me to asking for a volunteer to jump right in and finish out this year as secretary.

Our October meeting should be very interesting. Fellow V-8er, RALPH HUBBARD will talk to us about appraisals and what makes your car valuable. Don't miss out on this top-secret info.

NOW is the time to volunteer to become an officer for 1996. It's your club and your service is needed. Please see Dick Smith or myself to volunteer!

In the past years we have collected food at Thanksgiving time for some of the less fortunate families in our community. Let's all bring some canned goods and non-perishable food items to the NOVEMBER meeting. Last year we collected five large boxes of food. Let's make it 6 or more this year. Please!

Our Christmas party this year should be a real nice evening of fun, food and friendship. Look for the details inside.

Looking forward to seeing you all in our regular meeting place on October 1st.

Your Prez., Jerry

Program for Sunday, October 1st, will be held at the

**GLENDALE FEDERAL SAVINGS
21821 DEVONSHIRE, CHATSWORTH**

TIRE KICKING 7:00 P.M.

MEETING 7:30 P.M.

Our October meeting will have as our speaker and program, **RALPH HUBBARD** – speaking to us about Car Appraisals. Car Appraisals are very valuable to us, because it not only determines the value of your car, but is especially useful for insurance purposes.

Bring a friend and your classic auto and attend!!!

JACKPOT

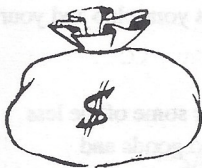

\$20.00

Could Be Yours!

(You just have to be present and wear your name badge to win.)

SECRETARY'S VIEWPOINT

Meeting #9 of 1995 was not like any other meeting we had thus far, this year. Because we had two speakers for the evening.

President Jerry Littner arrived in his 1940 FORD Tudor Sedan, as promised. Jerry said he didn't remove the hood, fenders or grille to get the engine in place. Only the radiator was removed. Nice job Jerry...Lesley said it was nice to have Jerry in the house, again!

The guests for the evening were Taleen Kelegian, guest of Whitney Rydbeck and Aladdin (the "Guiding Eyes Dog - In Training"), was my guest.

The "Name Badge" drawing winner was BEN DiFATTA! Congratulation Ben, take Isabel to lunch!

Ben DiFatta was our first speaker for the evening. Ben shared some of his photographic talents, while he was with Lockheed, from the Cheyenne helicopter to the C-5s and a lady on the beach? Who was that lady...ask Ben.

Ben told us that he worked in the photography department for 35 years and was a photographer for 29 of those years. Ben, also told us that 1/3 of the development of an aircraft goes toward security.

Whitney Rydbeck was our second speaker for the evening. Whitney is the gentleman with the '46 FORD Taxi, which, was the one used in "Whitney and the Robot" series that ran from 1979 to 1988. And Whitney was used in that program, too.

Whitney told us how the network bought the '46, twice. Then he bought it once, when the series ended.

Whitney is still active in theater productions.

Thanks goes to Blacky Blackwell for providing us with those delicious cookies, for our break.

Respectfully, Jim Winnett



PEPPERMILL 1995 REPORT

Any way you look at it, the Peppermill meet this year was a great success, Attendance was an even 132 very nice people. The cars were all interesting and high quality and the food was good. All together, I believe everyone had a really good time. We were especially pleased to see a larger turnout from both the San Diego and Lincoln groups this year as compared to last year. The attendance of the Lincoln people and their cars is a nice addition to the Peppermill. This tradition started last year. Our thanks to George Richards for introducing them to our event. Certainly our most sincere thanks to three special ladies - Gerry Blackwell for judging, Lesley Littner for ticket sales, and Julie Ochsner for creating the picnic basket and buying the door prizes.

It was my pleasure to serve the club this year as chairman of the Peppermill Brunch. I want to extend a very personal thanks to all of you who attended and made the event a peasant experience.

Dudley Ochsner

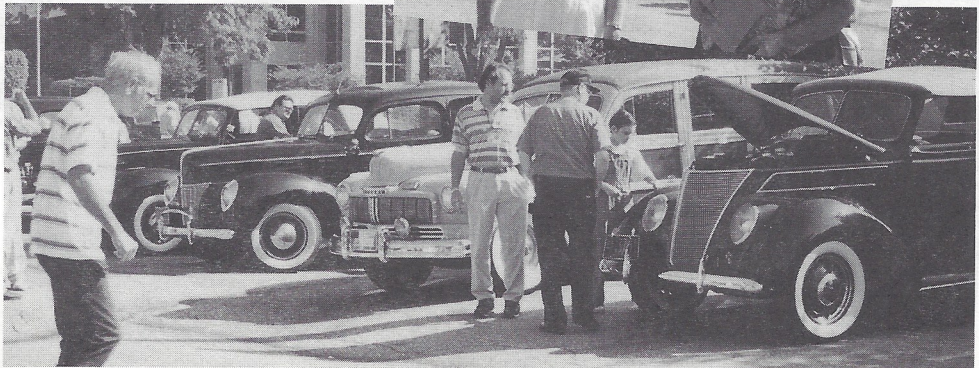
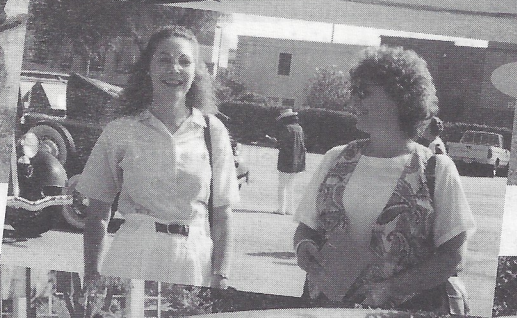
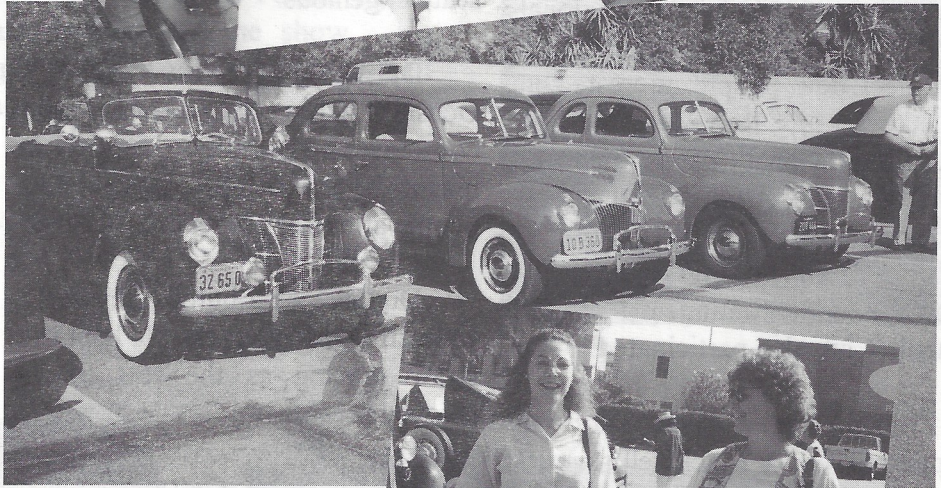
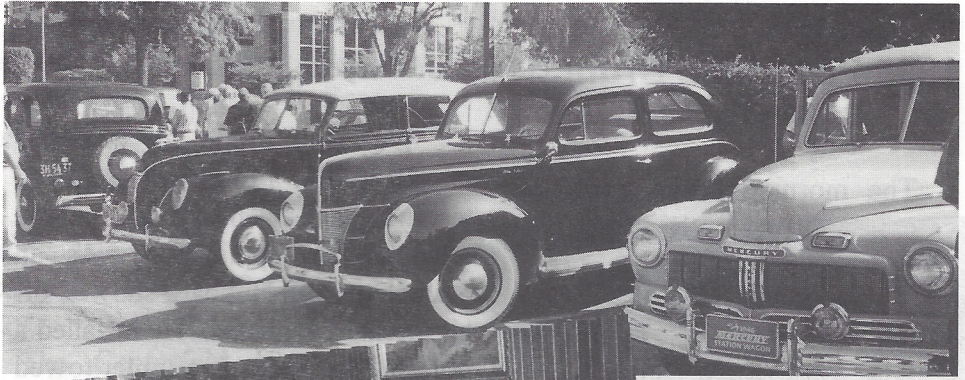

1995 Pasadena Brunch

By David Sanborn

The morning broke cool and overcast. At promptly 9am, Jerry and Carole Jensen picked Christine and me up at our home in Northridge. We entered the Jensen's Dearborn Award 1939 Tudor, freshly repaired from earthquake damage. Off we went to the 10th Pasadena Brunch Tour.

This breakfast tour continues it's success in getting California Regional Groups together to renew friendships and meet new people interested in collector cars. Representatives of most area Regional Groups attended. We saw people from Ventura, San Fernando Valley, Southern California, San Diego and Baldy View. A large contingent from the Lincoln Club also participated.

When we arrived at the Peppermill Gerry Blackwell slapped a number on a headlight. I later discovered that the number identified the car for a vote of several award categories selected by all the women attending. This reverse gender discrimination rule (no men allowed to vote) carried on a tradition set at the beginning of the event in 1986. This rule continues to be popular

with everyone.

We went inside for a hearty breakfast after a too short period of visiting and observing unique technological applications. As an example, Ralph Hubbard showed off his mechanical marvel. He installed a portable generator in a trailer towed by his 1938 Sedan. The generator powers an air conditioner in the trunk of his car. The air conditioner blows cold air into the passenger compartment past the lowered rear seat. Ingenious.

During breakfast Dudley Ochsner, who also organized and coordinated the event, served as master of ceremonies. He said 132 people attended. A record.

Dudley distributed several interesting raffle prizes. He kept the show moving as the rest of us enjoyed breakfast.

For the finale, Gerry Blackwell announced the prize winners.

The Bekins (Best Commercial) went to the '34 Ford panel owned by Weston and Elona Hook.

A Blue '42 Lincoln owned by John Malta won The Dipstick (Needs Help).

Gayle and Mickey Remund won The Fonz (Best Street Rod or Custom) with their '34 Ford 5 Window Coupe.

Best Convertible, The Chippendale, went to George Richards with his 1939 Convertible.

The Centerfold (Best Body/ Most Fun) suited the 1940 Ford Pickup driven by Guy and Esther Allen.

Richard Gillette completed restoration on his '33 Fordor Sedan four days before the show. He appropriately won The Hunk (Best of Show).

We look forward to the Pasadena Brunch next year.



SUPPORT OUR ADVERTISERS!



INCENTIVE CONNECTION TRAVEL

1940 E. Thunderbird Rd.
Suite 105
Phoenix, AZ 85022
(602) 867-9606

Travel Agent
Beverly Dupr e
(818) 883-2747

FLIP SMITH



7735 SEPULVEDA BOULEVARD
VAN NUYS, CALIFORNIA 91405
Bus: (818) 786-8686
Fax: (818) 785-2982

DON'S Auto Parts

MACHINE SHOP and BALANCING

Monday thru Friday 8 a.m. to 7 p.m.
Saturday 9 to 6 - Sunday 10 to 4

10241 Woodley (At Devonshire)

Domestic &
Foreign
Parts & Supplies



(818)

894-6441

Sepulveda, CA 91343

RAFFLE PRIZE DONOR

LESLEY A. LITTNER
(818) 597-9016 / FAX:597-9145

BOOKKEEPING & BUSINESS SERVICES

5051 BLACKPOOL AVE.
AGOURA, CA. 91301



Older Cars
A Specialty

4 x 4's and
Motorhomes

Russell Sylvis, Inc.

Transmissions
Repaired • Rebuilt

(805) 527-4387

4657 Barnard St.
Simi Valley, CA

R.C. Smith's Roofing Solutions

Roofing & Waterproofing • Complete Maintenance Service

8707-D Lindley Ave., Ste. 199, Northridge, CA 91325
Lic. #356650 (818) 718-2313

Auto • Homeowners

- ANTIQUE CARS -

ED HARDIN INSURANCE

Business • Life • Health • Aircraft



Call us for your Insurance needs!

(818) 363-7864

ALLAN FRANKLIN'S BATTERY TENDER

\$59.99

club members
\$54.99

Charges battery up and turns itself off
automatically when it fully charged.
Takes the guess work out of battery maintenance!

(818) 842-2230

6, 8, or 12 Volt Models

SUPPORT OUR ADVERTISERS!

L.T. "LEE" SAWYER, INC.

Jobber

Shell Oil and Chemical Products

14117 Aetna Street, Box 369
Van Nuys, California 91408

TOM SAWYER (818) 786-8180 / (818) 785-0902

RAFFLE PRIZE DONOR



(818) 776-3290
FAX (818) 776-3291

TERRY Sash & Door

6057 Reseda Boulevard, Tarzana, CA 91356

"Able to service all your Sash & Door needs"

New Owner! New Location!

Ford Obsolete Parts

Your Local Source for NEW, USED & REPRODUCTION PARTS



Vintage & Classic

Car & Truck



1909-27 "T" • 1928-31 "A" • 1932-53 V8

Friendly, Helpful Service — 10% Discount To Club Members

Phone **818-982-5303** or **818-295-2685**

8:30 am - 6:00 pm Mon - Fri

9:00 am - 3:00 pm Sat

2126 Floyd Street, Burbank, CA 91504

RESIDENTIAL • COMMERCIAL • INVESTMENT



Spencer Realty

5948 Goodland Ave.
Studio City, CA 91604
Office: 818-761-1754
Fax: 818-761-7952



AL SPENCER

QUALITY PROFESSIONAL SERVICE

CARS FOR SALE

'35 FORD PICKUP

59 AB engine, hydraulic brakes, tube shocks on rear. Dark green body and fenders. \$7,000.00, OBO.

'34 FORD 4-DOOR DELUXE

Cream color, rear mounted spare with full cover, greyhound radiator cap, 59AB engine, hydraulic brakes, tube shocks on rear, Fenton cast iron head-ers, vinyl upholstery and head-liner. \$12,000.00, OBO.

Both these vehicles were restored several years ago, but have been sitting in a carport

covered by a tarp for 3 years. I have photos that show how great these vehicles were, and how they could be again if they were cleaned up. Both have California historical Plates, and the titles and licenses are current. Shortly after restoration, the pickup was appraised at \$9,800, and the 4-door at \$14,000. The cars are in Pasadena. Contact Miles Schofield, 818-342-8881.

MISC.

1932-1935: FORD WIRE

WHEELS: With Tires \$100.

Bill Welch (805) 255-0163.

PAST PRESIDENTS

JIM ROWE.....	1971
DOUG PETERSON	1972
DON DURKEE	1974
ED WARNOCK	1975
JOHN BUSK.....	1976
CHIP WERSTEIN	1977
STAN MARSRAJE.....	1978
BOB DRAKE	1979
BILL CULP.....	1979
AL SPENCER.....	1980
LARRY CAPLAN	1981
BOB ROSE	1982
DON DURKEE	1983
PAUL KIRK	1984
KENT LOWRY	1985
DAVE SANBORN.....	1986
JOHN KEMMERER	1987
DUDLEY OCHSNER.....	1988
JERRY JENSEN	1989
JERRY JENSEN	1990
JOE DIFATTA	1991
CHUCK SHUBB.....	1992
CHUCK SHUBB.....	1993
GEORGE RICHARDS	1994

Meetings are held on the first Sunday of every month at 7:00 p.m.

The Valley  **'s**

5051 BLACKPOOL AVE., AGOURA, CA 91301

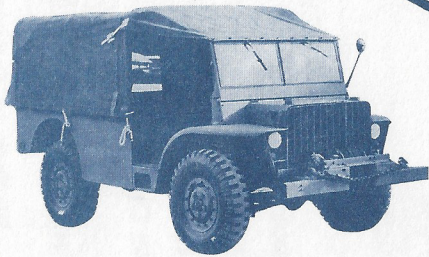
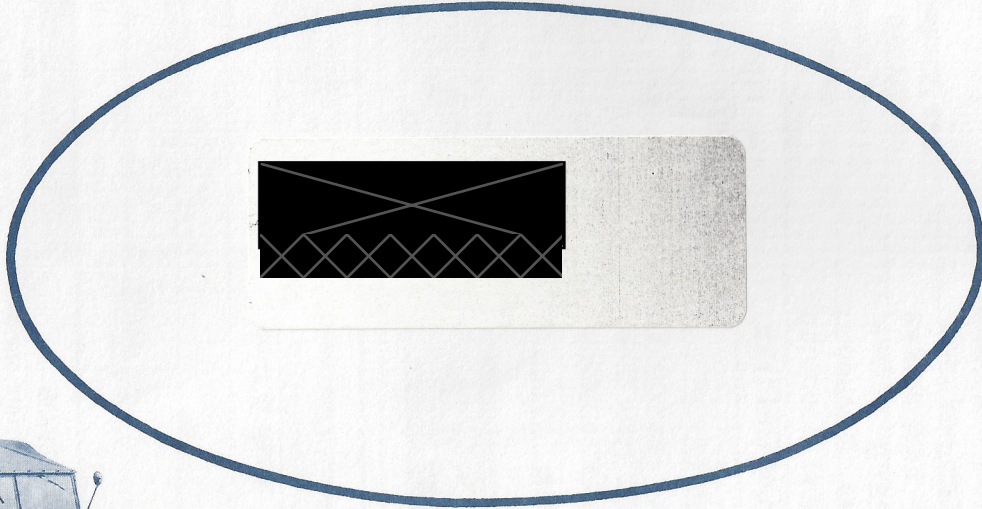
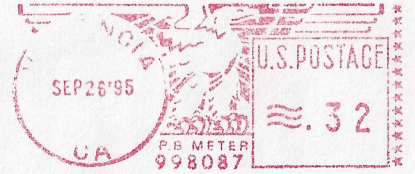

1945 Ford Cargo Truck