

25

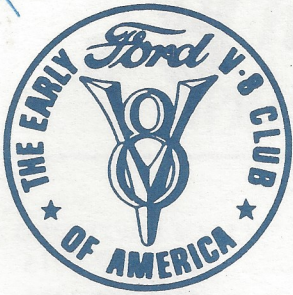

DECEMBER

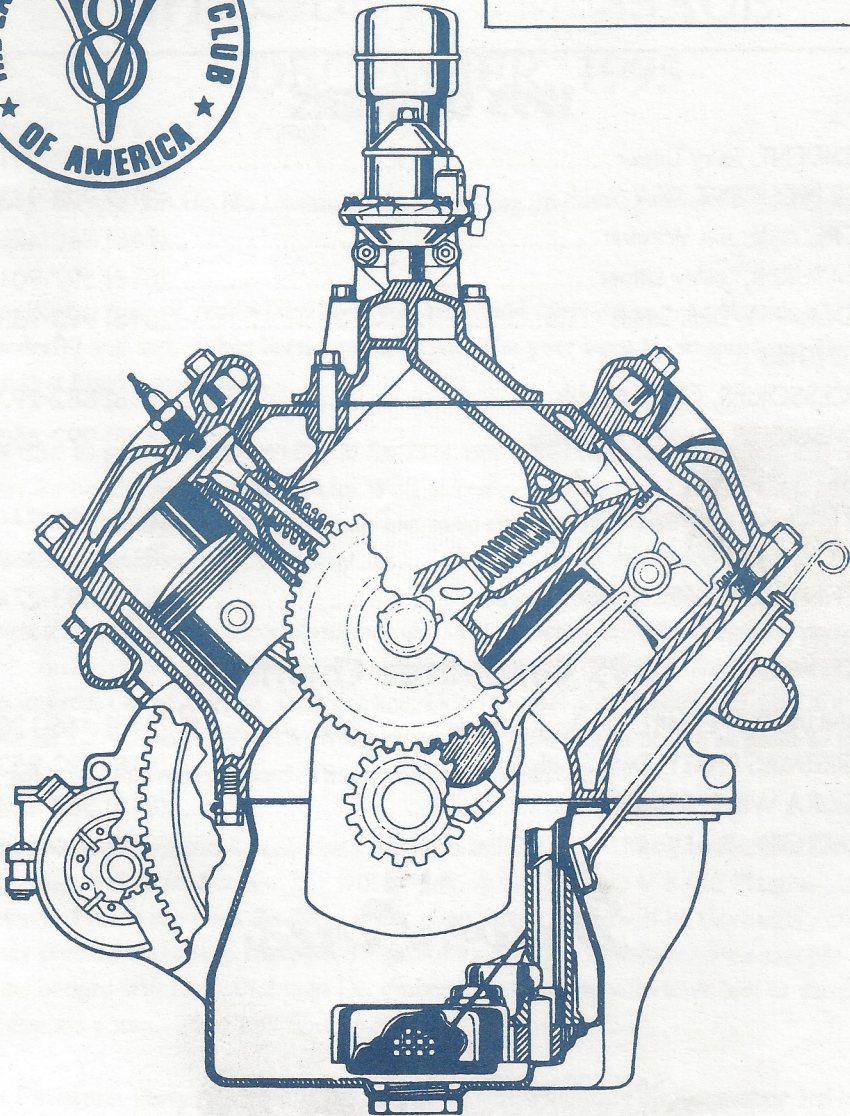

Drive Lines

The Valley 's

1995 OFFICERS

PRESIDENT, Jerry Littner	(818) 597-9016
VICE PRESIDENT, Dick Smith	(818) 993-9538
SECRETARY, Jim Winnett	(818) 768-4228
TREASURER, Lesley Littner.....	(818) 597-9016
PROGRAMS, Dick Smith	(818) 993-9538
ACTIVITIES	
ACCESSORIES, Chuck Shubb	(818) 882-2927
MEMBERSHIP, George Richards.....	(818) 992-4537
FELLOWSHIP	
RAFFLES, Chuck Mair	(818) 785-9413
EDITOR, Miles Schofield.....	(818) 342-8881
TECHNICAL ADVISOR, Don Dupree.....	(818) 883-2747

1995 Committee Chairmen

ANNUAL PEPPERMILL, Dudley Ochsner.....	(818) 446-1206
CHRISTMAS PARTY, Dick Smith	(818) 993-9538
TEQUILA WILLIE'S, Bob Rose	(818) 362-4842
DIRECTORY, Paul Kirk.....	(818) 886-5467

Drive Lines

Published By

SAN FERNANDO VALLEY CHAPTER 40
of the EARLY FORD V8 CLUB OF AMERICA

P.O. Box 96
Reseda, CA 91335

COVER/ROY JONES

The Valley V8's

PRESIDENT'S MESSAGE

DECEMBER, 1995

GREETINGS VALLEY V-8ers:

Merry, Happy, Ho Ho Ho ! Santa Claus is revving up the engines on the Reindeer. It's that time of year again.

It's also the time of year where I bid you all a fond farewell as your President. This feels wonderful and sad. It has been a great honor. The year went by so quickly. This must be a sign that I had a good time.

It is time to pass the baton to DICK SMITH, our next President. Dick has lots of fresh ideas for next year - including John Wolf as our next Vice-President. Please offer him your support and ideas. Together we can have the best club year yet. 1996 will be our club's 25th Anniversary. Amazing!

I want to express my sincere thanks to the 1995 officers and all the special people who have come to my rescue. Special thanks go out to Dave Sanborn, Joe DiFatta , Cal Beauregard, Dennis Keene, Don Durkee, Don Dupree, and Dudley Ochsner for their MAJOR LEAGUE EFFORTS. Without you, our club would not be as great as it is - and my job would have been hard. Thank you one and all.

Now onto some business. Our dues for 1996 will be \$25. This is because of the high price of postage and related costs. We will be getting our "Valley V-8 Car Plaques" sometime in January. Please see Dick Smith to order yours now. They will be thoroughly cool and nicely painted and cost \$16.50 each. Please look in this newsletter for a sample design. Name badges will be available in December for all of you who have lost or misplaced or the dog ate yours. They will cost \$6.00 each.

Our Christmas Party this year at the Smoke House restaurant on December 3rd looks to be the event of the season. Don't miss out ! We will have both a Turkey and Ham raffled off. You could have a good ole time AND bring home your holiday dinner's main course. We will also be installing our new president and officers.

Wishing you all the best in 1996 -health, happiness, prosperity and a Ford in your garage. Happy New Year. Happy Motoring.

Your Prez. Jerry

1995 ANNUAL CHRISTMAS PARTY
SUNDAY, DECEMBER 3RD - 6:00 P.M.
FORD PARKING IN THE LOT ACROSS THE STREET
THE SMOKE HOUSE RESTAURANT

4420 LAKESIDE DRIVE
BURBANK, CA. 91505



MENU SELECTIONS:

- >PRIME RIB OF BEEF
- >BROILED ORANGE ROUGHY
- >CHICKEN TERIYAKI SERVED OVER RICE

DINNERS SERVED WITH SALAD, VEGGIES,
POTATO/RICE, DESSERT & COFFEE OR TEA.

.....\$25.00 PER PERSON.....



DON'T MISS OUT ! JOIN IN THE FUN AT

THE VALLEY V-8 CHRISTMAS PARTY.

WE WILL RAFFLE OFF A TURKEY & HAM.

YOU MIGHT WIN THE MAIN COURSE.

**BRING AN UNWRAPPED TOY FOR A
"LESS FORTUNATE CHILD" TO THE
VALLEY V-8 CHRISTMAS PARTY !
THANK YOU.**

4TH AND LONG...PUNT
SECRETARY'S VIEWPOINT

On November 5th, our 11th meeting of the year started out with President Jerry saying this was our last chance to impeach him. No takers. Dick Smith told us about the soon to be available Club Plaques. Then he told us about his tour with the Ventura Club to Death Valley and Scotty's Castle. He had just returned hours before the meeting and, shared a few nightmare-breakdown stories with us. He also said it was a terrific tour.

We had two guests attend our meeting. Nancy Nachtman, who owns a '40 Ford that is in the restoration stage and the 'Brother-in Law' of member Steve Sadd. Sorry, I missed his name.

We raffled off two Thanksgiving turkeys - one organic and one Butterball. Winners were Lin Kemmerer and Doug Peterson. When asked what time to show up for dinner - no reply was heard.

Prez. Jerry thanked everyone who brought canned goods for their noble efforts. Joe DiFatta will be taking the food stuffs to the Van Nuys Rotary Club for distribution through their programs. Thanks Joe.

Our program speaker was our own Joe DiFatta. Joe shared his experiences with touring and traveling in his 26 foot motorhome. He covered 6,000 miles and used more than 1,000 gallons of fuel. The ultimate destination on this journey was to attend Marsha's family reunion. On the way they stopped at most every car museum and car-related town ON and OUT of their way. Then we heard a hearwarming story from Ralph Hubbard. He told us about how driving an old V-8 seems to make people go out of their way to offer help and kindness. Way to go Ralph. You restored my faith in "the good people of Nebraska and the mid-west".

The meeting ended with uplifted spirits and great parking-lot conversations.

With kindest regards,

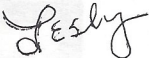

Lesley Littner
4th & long - Punt Secretary

**SAN FERNANDO VALLEY
COMMUNITY MENTAL HEALTH
CENTER, INC.**

A Non-Profit Corporation

Administrative Offices: 6740 Kester Ave., Van Nuys, California 91405 (818) 901-4830

Mr. Joe DiFatta
Valley V-8 Ford Club
c/o DiFatta Graphics, Inc.
27642 Ave. Hopkins
Valencia, CA 91355

November 13, 1995

Dear Ford Members:

On behalf of the staff and clients at the San Fernando Valley Community Mental Health Center, Inc., I would like to thank you for your most generous donation of two boxes and two large bags of canned goods.

We distributed your contribution to our Cornerstone program, which serves adults who are homeless and suffering from mental illness. As there are community fewer resources for those in need, we are beginning to see a marked increase in the number of people we serve - which means we have a lot more hungry people to feed!

When I informed the Cornerstone staff that you were sending food, they were thrilled. They anticipate approximately 400 for Thanksgiving dinner, so your donation came in the nick of time.

Thanks to all of you for your continuous support of the Center and our clients. We wish you a very happy and healthy holiday season, and we truly appreciate your efforts on our behalf.

Sincerely,



Catherine Carson
Director of Public Relations

HOLIDAY CRANBERRY NUT BREAD

- (2)Tbsp. shortening**
- (1) egg**
- (1) cup sugar**
- (1/2) tsp. salt**
- (2) cups flour**
- (1/2) tsp. baking powder**
- (1/2) tsp. baking soda**
- (1/2) cup pecans or walnuts, chopped**
- (1) cup cranberries, chopped**
- grated rind of one orange**
- juice of one orange, with water added to make**
3/4 cup of liquid

Melt the shortening and set aside. In a large bowl, beat the egg and mix in the sugar, salt, shortening, and grated rind. In a separate bowl, sift together the flour, baking powder, and baking soda. Add the flour mixture and orange juice liquid to the egg mixture, beating until batter is smooth. Add the cranberries and nuts. Mix thoroughly. Pour batter into small greased loaf pan and bake for approximately 60 minutes at 350 degrees. (Makes three mini-loaves)

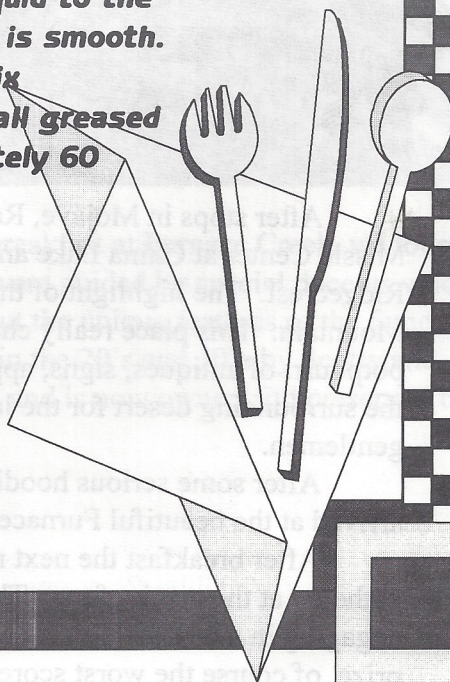
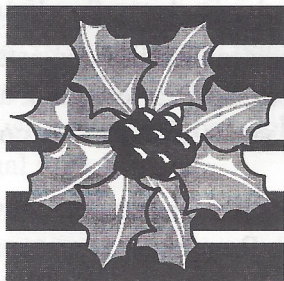

Ventura V-8's - Regional Group # 84

Annual Fall Classic Tour

The 9th Annual Fall Classic Tour to Death Valley got off to an early start on Friday, November 3, 1995. 53 members, friends and a few wellwishers met at the Agua Dulce ranch of Blacky & Gerry Blackwell for a hearty full-on breakfast and send off. After greeting the cat, Merc, checking out the fish in the fish pond and shopping in The Country Cottage, each couple received a "Desert Water Bag", tour bag containing Death Valley maps and tour information and a quiz, also Sweetwater Creek Energy Bars for a mid-morning snack.. After breakfast 23 freshly shined and tuned old Fords departed led by tour chairperson, Gerry Blackwell.

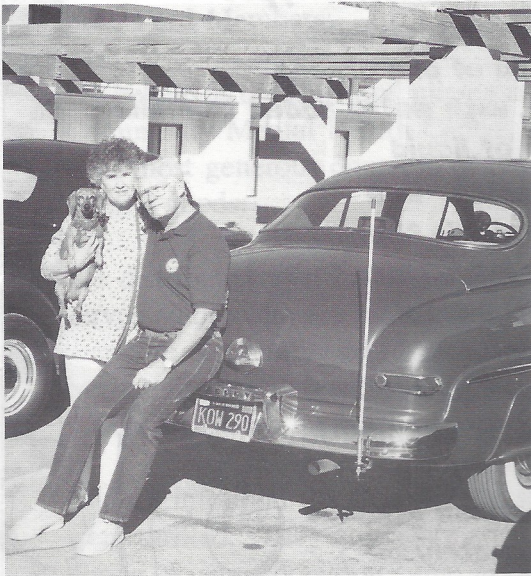

After stops in Mojave, Randsburg, and Inyokern we toured the Navel Missile Center at China Lake and then had lunch at a local park in Ridgecrest. The highlight of the morning had to be the PPJ Museum of Red Mountain. This place really challenges reality and consists of a large potpourri of antiques, signs, appliances, and various junk all collected from the surrounding desert for the last 25 years, by two very colorful old gentlemen.

After some serious hoodlifting and a gas stop in Stovepipe Wells we arrived at the beautiful Furnace Creek Ranch just after sunset.

After breakfast the next morning, veteran V-8'ers warmed up and gathered at the crack of ten. The Ventura V-8's have a long tradition of engaging in a 6 hole "Trash Can Frisbee" contest and the winner gets a nice prize, of course the worst score gets the dreaded rubber chicken!

After visiting the various historic and mining sites for which Death Valley is famous, and a decadent lunch at the Furnace Creek Inn, we freshened up and moved into the evening activities. This included a nice chicken and steak barbeque followed by a full moonlit bus tour to The Amargosa Opera House at Death Valley Junction, where we watched an outstanding performance by 71 year old vaudeville star, Marta Beckett. All members were thrilled when we were told Red Skelton would be in attendance and many members were able to shake hands and talk to Red, both before the performance and after.



The following morning, after breakfast at Furnace Creek, we toured to Death Valley Scotty's Castle and were guided by special docents who told stories, 1939 style, and pointed out the unique features of the famed old desert mansion. The castle was built in the 20's and 30's by Scotty and wealthy business man Albert Johnson and is now owned and preserved by the National Park Service.

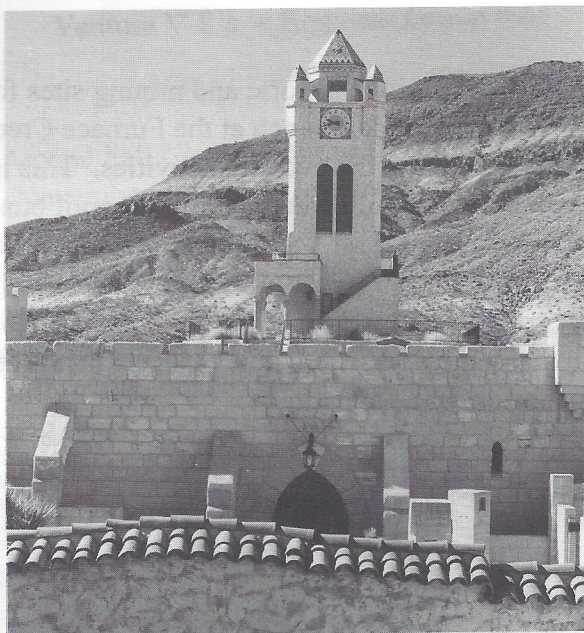

Long distance award went to Jerry & Jo Veley from Boring, Oregon and the winners of the hard luck award were Al & Ruth Spencer of Studio City.

The quiz consisted of questions about Death Valley and the movie "American Grafitti" and was won by Gerry & Janet Bachmann of Camarillo. The "Trash Can Frisbee" winners were Gerry Bachmann and John Urgo.

We all departed at about noon from Scotty's Castle and everybody agreed the tour turned out to be the largest and most exciting Fall Tour so far.

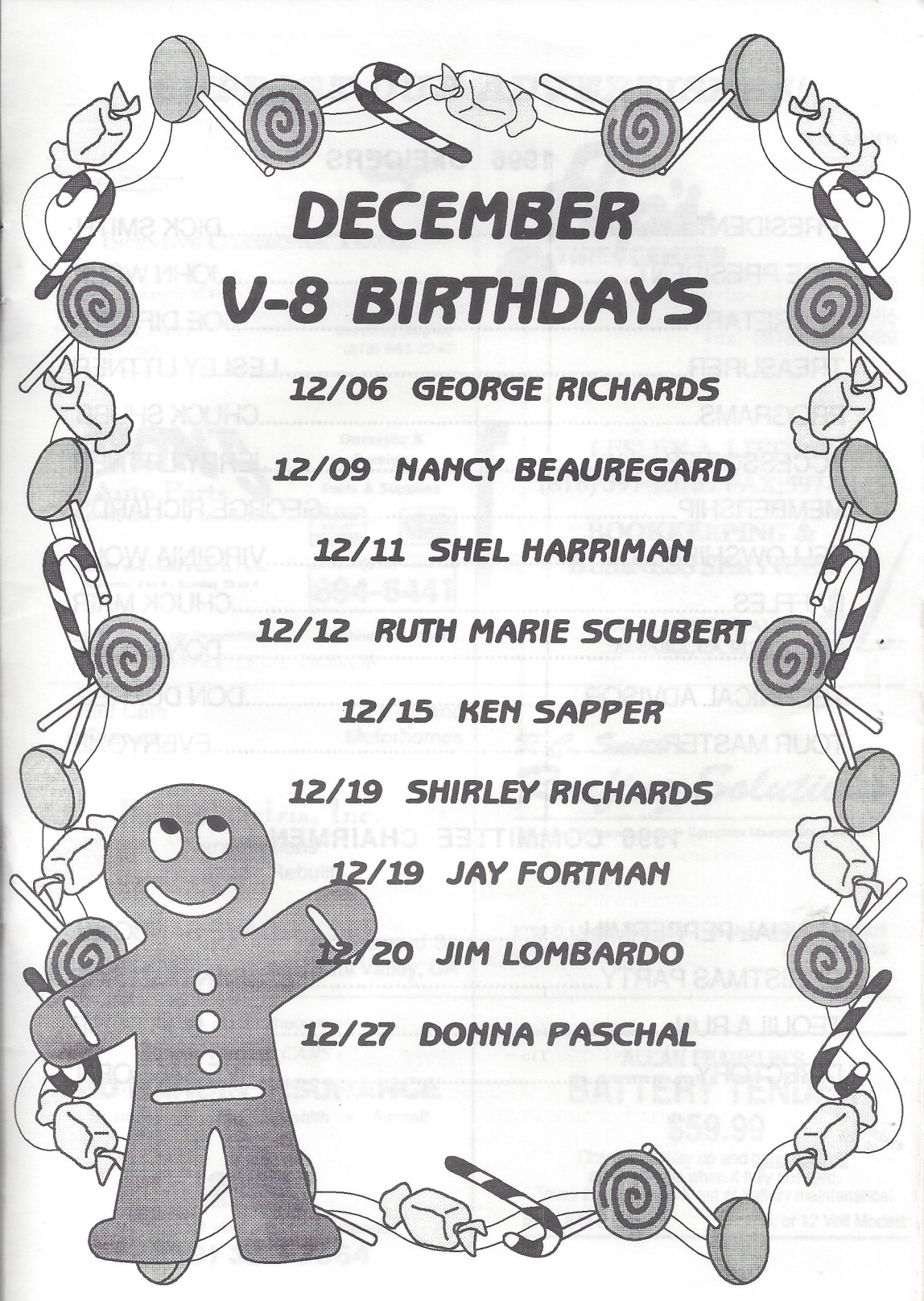

**DECEMBER
V-8 BIRTHDAYS**

12/06 GEORGE RICHARDS

12/09 NANCY BEAUREGARD

12/11 SHEL HARRIMAN

12/12 RUTH MARIE SCHUBERT

12/15 KEN SAPPER

12/19 SHIRLEY RICHARDS

12/19 JAY FORTMAN

12/20 JIM LOMBARDO

12/27 DONNA PASCHAL



1996 OFFICERS

PRESIDENT.....	DICK SMITH
VICE PRESIDENT.....	JOHN WOLF
SECRETARY.....	JOE DIFATTA
TREASURER.....	LESLEY LITTNER
PROGRAMS.....	CHUCK SHUBB
ACCESSORIES.....	JERRY LITTNER
MEMBERSHIP.....	GEORGE RICHARDS
FELLOWSHIPS.....	VIRGINIA WOLF
RAFFLES.....	CHUCK MAIR
EDITOR.....	DON STOUT
TECHNICAL ADVISOR.....	DON DUPREE
TOUR MASTER.....	EVERYONE

1996 COMMITTEE CHAIRMEN

ANNUAL PEPPERMILL.....	DAVE SANBORN
CHRISTMAS PARTY.....	SANTA CLAUS
TEQUILA RUN.....	BOB ROSE
DIRECTORY.....	DAVE SANBORN

SUPPORT OUR ADVERTISERS!



INCENTIVE CONNECTION TRAVEL

1940 E. Thunderbird Rd.
Suite 105
Phoenix, AZ 85022
(602) 867-9606

Travel Agent
Beverley Dupr e
(818) 883-2747

FLIP SMITH



7735 SEPULVEDA BOULEVARD
VAN NUYS, CALIFORNIA 91405
Bus: (818) 786-8686
Fax: (818) 785-2982

DON'S Auto Parts

MACHINE SHOP and BALANCING

Monday thru Friday 8 a.m. to 7 p.m.
Saturday 9 to 6 - Sunday 10 to 4

10241 Woodley (At Devonshire)

RAFFLE PRIZE DONOR

Domestic &
Foreign

Parts & Supplies



(818)
894-6441

Sepulveda, CA 91343

LESLEY A. LITTNER
(818) 597-9016 / FAX:597-9145

BOOKKEEPING & BUSINESS SERVICES

5051 BLACKPOOL AVE.
AGOURA, CA. 91301



Older Cars
A Specialty

4 x 4's and
Motorhomes

Russell Sylvis, Inc.

Transmissions
Repaired • Rebuilt

(805) 527-4387

4657 Barnard St.
Simi Valley, CA

R.C. Smith's Roofing Solutions

Roofing & Waterproofing • Complete Maintenance Service

8707-D Lindley Ave., Ste. 199, Northridge, CA 91325
Lic. #356650 (818) 718-2313

Auto • Homeowners

- ANTIQUE CARS -

ED HARDIN INSURANCE

Business • Life • Health • Aircraft



Call us for your Insurance needs!

(818) 363-7864

ALLAN FRANKLIN'S BATTERY TENDER

\$59.99

club members
\$54.99

Charges battery up and turns itself off
automatically when it fully charged.

Takes the guess work out of battery maintenance!

(818) 842-2230

6, 8, or 12 Volt Models

SUPPORT OUR ADVERTISERS!

L.T. "LEE" SAWYER, INC.

Jobber

Shell Oil and Chemical Products

14117 Aetna Street, Box 369
Van Nuys, California 91408

TOM SAWYER (818) 786-8180 / (818) 785-0902

RAFFLE PRIZE DONOR



(818) 776-3290
FAX (818) 776-3291

TERRY Sash & Door

6057 Reseda Boulevard, Tarzana, CA 91356

"Able to service all your Sash & Door needs"

New Owner! New Location!

Ford Obsolete Parts

Your Local Source for NEW, USED & REPRODUCTION PARTS



Vintage & Classic

Car & Truck



1909-27 "T" • 1928-31 "A" • 1932-53 V8

Friendly, Helpful Service — 10% Discount To Club Members

Phone **818-982-5303** or **818-295-2685**

8:30 am - 6:00 pm Mon - Fri

9:00 am - 3:00 pm Sat

2126 Floyd Street, Burbank, CA 91504

RESIDENTIAL • COMMERCIAL • INVESTMENT



Spencer Realty

3948 Goodland Ave.
Studio City, CA 91604
Office: 818-761-1754
Fax: 818-761-7952



AL SPENCER

QUALITY PROFESSIONAL SERVICE

FOR SALE

1934 Ford Convertible

Unrestored, but all together, "NO RUST"

5 New Firestone wide W.W. tires and tubes.

LeBaron-Bonney interior kit, top kit & rumble seat kit

\$13,000.00

Gene Wilson - (818) 249-8950

CALL AFTER 7:00 P.M.

PAST PRESIDENTS

JIM ROWE.....	1971
DOUG PETERSON.....	1972
DON DURKEE.....	1974
ED WARNOCK.....	1975
JOHN BUSK.....	1976
CHIP WERSTEIN.....	1977
STAN MARSRAJE.....	1978
BOB DRAKE.....	1979
BILL CULP.....	1979
AL SPENCER.....	1980
LARRY CAPLAN.....	1981
BOB ROSE.....	1982
DON DURKEE.....	1983
PAUL KIRK.....	1984
KENT LOWRY.....	1985
DAVE SANBORN.....	1986
JOHN KEMMERER.....	1987
DUDLEY OCHSNER.....	1988
JERRY JENSEN.....	1989
JERRY JENSEN.....	1990
JOE DiFATTA.....	1991
CHUCK SHUBB.....	1992
CHUCK SHUBB.....	1993
GEORGE RICHARDS.....	1994

Meetings are held on the first Sunday of every month at 7:00 p.m.

