

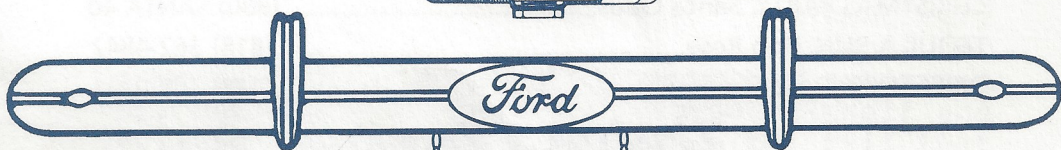

NOVEMBER

Our 25th Year

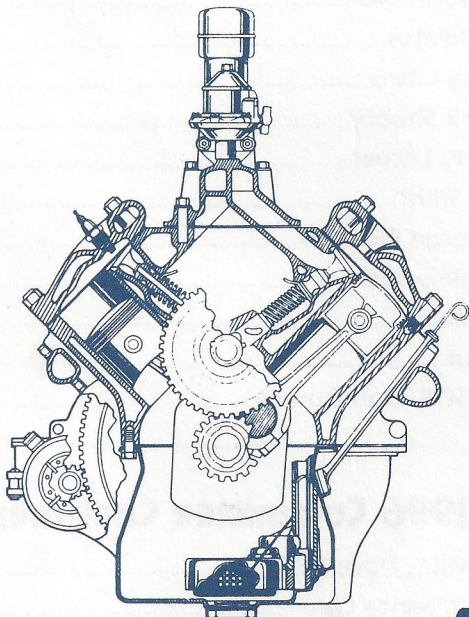

San Fernando
Valley 's
CHAPTER 40



Drive Lines

The Valley s

1996 OFFICERS

PRESIDENT, Dick Smith.....	(818) 368-5890
VICE PRESIDENT, John Wolf.....	(818) 789-6201
SECRETARY, Joe DiFatta.....	(818) 700-1939
TREASURER, Lesley Littner.....	(818) 597-9016
PROGRAMS, Chuck Shubb.....	(818) 882-2927
ACCESSORIES, Jerry Littner.....	(818) 597-9016
HISTORIAN, Patti Smith.....	(818) 368-5890
MEMBERSHIP, George Richards.....	(818) 992-4537
FELLOWSHIP, Virginia Wolf.....	(818) 789-6201
RAFFLES, Chuck Mair.....	(818) 785-9413
EDITOR, Don Stout.....	(818) 998-7054
TECHNICAL ADVISOR, Don Durkee.....	(805) 495-5298
TOUR MASTER.....	EVERYONE

1996 Committee Chairmen

ANNUAL PEPPERMILL, Dave Sanborn.....	(818) 709-0741
CHRISTMAS PARTY, Santa Claus.....	(800) SANTA 40
TEQUILA RUN, Bob Rose.....	(818) 362-4842
DIRECTORY, Dave Sanborn.....	(818) 709-0741

Drive Lines

Published By

SAN FERNANDO VALLEY CHAPTER 40
of the EARLY FORD V8 CLUB OF AMERICA

P.O. Box 96
Reseda, CA 91335



PRESIDENT'S MESSAGE

November 1996

THE VALLEY V8'S 25TH ANNIVERSARY YEAR

Hello Fellow Club Members:

We had a good turn out in October, for our new meeting place at BAKERS SQUARE, and it was very quiet for a change. The parking was fair. I got there a little early at 6:00 and the lot was almost empty, but by 6:30 it was filling up, so come out a little early if you want good parking.

The winner for the \$20.00 JACKPOT name badge drawing was Lin Kemmerer, and the two ladies to win the door prizes were Gerry Blackwell and Georgia Munroe, and the trophy for October went to Ken and Dotti Schmelzel with there 1950 Merc CONGRATULATIONS to all of you. Do you know the name badge drawing has gone to two ladies this year, can you name the first lady that won.

Nominations for officers for 1997, went very well, we filled all of the offices, except for Programs, which Richard Valleroy was nominated for, but was not there to defend himself and declined the office, so we need to fill that spot.

I would like to thank you all for your support during the year, and next year as Tour Director, I hope to be seeing you out of my rear view mirror on as many tours as we can get in.

Yours Truly,

Dick Smith

November 5th
NEW MEETING PLACE
Bakers Square Restaurant

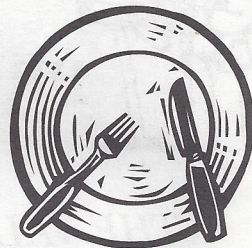

17921 Chatsworth Street
Granada Hills

(at the corner of Chatsworth St. and Zelzah Ave.)

6:30 PM PARKING LOT TIRE KICKING & VISITING
& Dinner if wanted, the food is good.
7:30 PM MEETING STARTS

Two ladies in attendance will receive a door prize.

The Trophy for the November 5th Meeting will be given to a early FORD 1932-53 product in the parking lot, to be chosen by George Richards, Jerry Jensen, and Chuck Shubb they are the judges, so bring your cars.

The name badge drawing (JACKPOT \$20.00), to be given to a club member in attendance that is wearing their badge.

The first and second place point leaders will be paid at this meeting.

***After Thirty Years Of Age,
A Body Has A Mind Of Its Own.
- Bette Midler***

SECRETARY'S COLUMN

As told to Joe D., from Lesley to Jerry to Chuck Mair, back to Jerry, then notes from Lesley and written by Joe D.!

Well, I guess the new place (Baker's Square) is great. Approx. 50 people in attendance, 18 classic cars... always neat to see our cars out on the road and not covered up in a garage!! (Burf!!)

President Dick started the meeting at 7:40. He had everyone introduce themselves and had the membership tell what cars they owned. We're up to date on the "Points" award, looks like we'll have a winner in November! The Ladies Raffle was won by Gerry Blackwell and Dottie Schmetzel. Trophy Winner for the Best Car in the lot was Ken & Dottie Schmetzel in their 1950 Mercury Coupe. We even had a Name Badge winner.. Lyn Kemmer.

Nominations for officers were made from the group that were present. You will get your chance to vote for this slate at the Nov. 5th meeting (thats also the government election day). Any questions regarding our elections ... Call Dick Smith.

Also in Bulletin is the renewal form to mail to Jerry & Lesley Littner with your \$25.00 check.

1997 Valley V8 Officers

(Election will be held Tues., Nov. 5th)

President	Chuck Mair
Vice President	John Wolf
Secretary	Craig Lapair
Treasurer	Lesley Littner
Program	
Tour Master	Dick Smith
Accessories	Al Rohrer
Raffles	Dick Stones
Reporter	Patti Smith
Editor	Don Stout
Membership	Jerry Littner
Social Secretary	Virginia Wolf
Technical Advisor	Larry Caplan

BETTER TRY

Editor Says.....

In my travels this month, I realized how lucky we car collectors are to be in Southern California. In Chicago, the cars are all put away for the winter; in San Francisco, a garage rents for over \$ 250.00/month to store one and the weather is not friendly. We have parts sources unlimited, both used and after market, lots of good preserved cars and some of the friendliest people to associate with in the world. Now let's not lose this to the environmentalists and have them all crushed as credits for industry to pollute.

Hopefully, my restoration is back on track this month. The steering wheel came back fully restored, looking good!

Some of you may have seen the chemical explosion and fire last week at *L.T. Sawyer, Inc.* In Van Nuys. Tom Sawyer is a big supporter of the Valley V-8's and an advertiser in our Drive Line, and has many old cars himself. I know we all wish him well in his clean-up and hopefully the reconstruction of a new warehouse.

Dues are due next month; let's all get them in early – See you at the November meeting!

Don Stout
(818) 782-4604

GET WELL DEPARTMENT

Cheryle Stout, slipped and fell
and broke her ankle (clean break).

Now home recuperating with
pins & plates and cast.

Send a card or note,
phone calls after Don gets
home from work.

The following cars and drivers have points towards the November JACKPOT

****	Virginia & John Wolf	17 points
***	Patti & Dick Smith	15 points
**	Rose & David Gott	13 points
*	Donna & Lloyd Paschal	14 points
*	Gerry & Blacky Blackwel	14 points
*	Lin & John Kemmerer	13 points
*	Dick Stone	12 points
*	Al Rohrer	11 points
	Lesley & Jerry Littner	11 points
	Shirley & George Richards	8 points
	Carole & Jerry Jensen	8 points
	Richard Valleroy	8 points
	July & Chuck Shubb	8 points
	Dottie & Ken Schmelzel	9 points
	Chuck Mair	9 points
	Mary & Don Durkee	7 points
	Sue & Steve Boskovich	6 points
	Jackie & Bob Monnick	6 points
	Wayne Burns	4 points
	Leslie Mac Willie	4 points
	Bob Reed	3 points
	Vicki & Dennis Keene	3 points
	Nancy & Cal Beauregard	3 points
	Ken Sapper	2 points
	Carlos Wilhelm	2 points
	Allen Franklin	3 points
	Dave Sandborn	2 points
	Ann & Larry Caplan	2 points
	Bill King	1 point
	Cheryl & Don Stout	1 point
	Bob Rose	1 point
	Richard Chutuk	1 point
	Barbara & Howard Simpson	1 point
	Jan & Ed Hardin	1 point
	Harold Johansen	1 point
	Joe Simon	1 point
	Joe Areana	2 point
	Kent Lowry	1 point
	Ed Warnock	1 point

LESS SPEED PER MILE

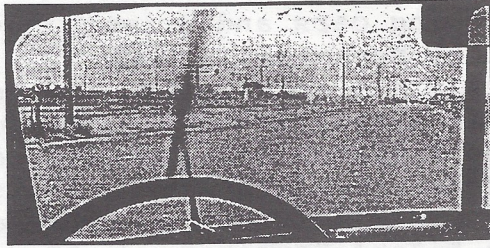

LOOKING AHEAD

November 3rd	Baldy View Car Show
November 5th	Monthly Meeting - Baker's Square
November 17th	Pomona Swap Meet
December 1st	Christmas Party - Smoke House
December 31st	Dues: Do-Dew-Due
September '97	Europe Tour

EARLY V8 FORDS DRIVEN TO THE MEETING

- 1938 FORD - Lee Chase
- 1950 FORD 4 DR - Ed & Jan Hardin
- 1950 MERC - Ken & Dotti Schmelzel
- 1940 FORD Cpe. - Dick Stone
- 1951 LINCOLN - Cal & Nancy Beauregard
- 1951 MERC - Allan Franklin
- 1940 FORD Wag. - Gerry & Blacky Blackwell
- 1940 FORD 4 DR - Al Rohrer
- 1940 FORD P-U - John & Virginia Wolf
- 1940 FORD Cpe. - Patti & Dick Smith
- 1950 MERC. 4 DR - Pam & Joe Areana
- 1953 FORD Cpe. - Donna & Lloyd Paschal
- 1941 FORD Conv. - Judy & Chuck Shubb

The other classic car driven was Don Stout's 1956 Chevy.

1996 Pasadena Brunch

By David Sanborn

My wife Christine and I pulled into the parking lot of the Peppermill Restaurant in Pasadena About 8:45 am on September 22. We thought we would be first to setup for the eleventh annual Peppermill Brunch. To our surprise and delight Bob and Gerrie Stoll had already arrived. It gave us an opportunity to get a private showing of their beautiful 1951 Ford pickup towing a completely restored 1947 Acme teardrop trailer. This trailer has ample space for sleeping inside and opens from the rear to display a fully equipped kitchen.

Soon representatives of five Regional Groups began filling the parking lot. A wide range of appealing cars brought by members of Baldy View, Valley V-8's, San Diego, Ventura and Southern California showed themselves for admiration. A total of eighty nine people registered for breakfast.

A cadre of raffle ticket sellers led by Lesley Littner busily sold tickets for fabulous prizes. Raffle prizes included ones made and donated by gracious members. Several individuals and Regional Groups contributed cash to help purchase other raffle prizes.

Gerry Blackwell again coordinated selection of cars to win plaques. She allowed only females to vote for award winners. Yes, we did practice reverse sexism. But, I believe everyone went away satisfied.

I personally felt impressed when I first saw Bob and Gerrie Stoll's camping arrangement. The judges agreed. They won Best of Show, THE HUNK, award with their immaculately prepared pickup and trailer. Bob and Gerrie represent the San Diego Regional Group with class.

The Special Award for the car needing most help went to Lee Foster for PAPASV8, a '41 Mercury Fordor. Lee told me he won four out of the last five years. He needs competition.

The Bekins (Best Commercial) went to GUYS40T, a '40 Ford pickup owned by Guy Allen from the San Diego Regional Group.

Dick Smith, President of The Valley V-8's, won the Fonz award for best street rod or custom with his 1931 Model A roadster. The car looked far from it's original configuration.

The best convertible selected by an independent vote went to Blacky Blackwell with his '40 Ford convertible. 01ARAG adorns the license plate of this recently finished CHIPPENDALE winner. Blacky and Gerry represent the Ventura Regional Group, among several others.

THE CENTERFOLD, best body most fun, went to Bob Costello and his black '36 five window coupe. Bob and his wife Rose represent the Southern California Regional Group.

During a hearty breakfast, again well prepared and served by the Peppermill staff, we received more great raffle prizes than I can count. I know Norm Booth won more than anyone. He even won one of the two super grand prizes, a KR Wilson rear hub puller in a deluxe display case.

The 1996 Peppermill Brunch continued an eleven year tradition. I recommend it as a fun, inexpensive way to visit old friends, make new ones and see cars that you may not observe at your own Regional Group meetings.

THAT SHE
COULD COOK
HE HAD HIS DOUBTS
UNTIL SHE CREAMED
HIS BRISTLE SPROUTS
WITH
BURMA-SHAVE

FAMOUS LAST WORDS
OF LIGHTS THAT SHINE
"IF HE WON'T
DIM HIS
I WON'T
DIM MINE"
BURMA-SHAVE

Makin' the old V-8 Cool!

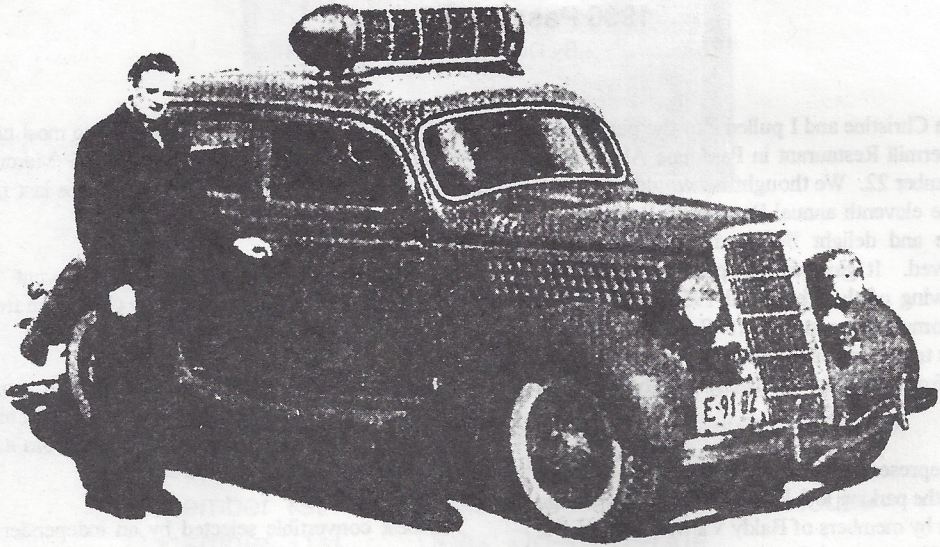

So you thought automobile air-conditioning was a relatively new accessory. Ain't so!

This 1935 Ford is equipped with some sort of air cooling device - I believe. (Evaporative Cooler?) Unfortunately, there wasn't any information with the photo, but as we sweltered away this past summer, many of us felt we could have used something like this on the old V-8! - Editor

Early Ford V-8 Club of America

Some of you may have missed this picture in the V8 Times. The V8 Times premiere magazine, well worth the nation dues; if you are not a member, you should be!

Without the magazine, the international dues are \$10.00 for one year. If you are not a member, you must sign waivers for each event.

Send in your application now!

THAT CAR

CLUB MEMBERS - SAVE
THIS FORM AND PASS IT ON
TO A PROSPECTIVE CLUB MEMBER.

\$32.00 per year

You're invited

TO JOIN

**THE EARLY FORD V-8 CLUB OF AMERICA
APPLICATION FOR MEMBERSHIP**

PLEASE PRINT

Name _____ Spouse _____

Address _____
STREET CITY STATE ZIP

Telephone No. () _____ Occupation _____
AREA

Cars Owned: _____ Referred By: _____

Year	Model	Body Style	Engine Type*	General Condition



**THE EARLY FORD
V-8 CLUB OF AMERICA
PO BOX 2122
SAN LEANDRO, CA 94577**

(Enclose check/money order for annual dues \$ _____ payable in U.S. funds.)

MAY HAVE TO

HOW LONG DO WE HAVE TO WAIT?!?

~ 8 OVERDUE O.E.M. ITEMS ~

BIFOCAL WINDSHIELD

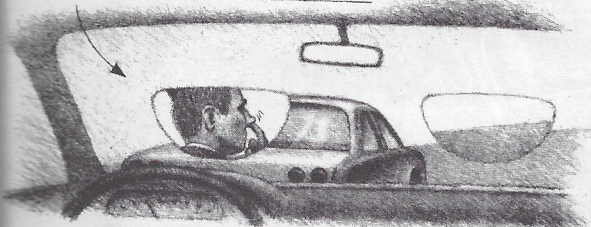

READ BUMPER STICKERS, SPOT VALUABLES IN ROAD, SHARE OTHER MOTORIST'S SECRETS (SHOWN)

HORIZONTAL STEERING

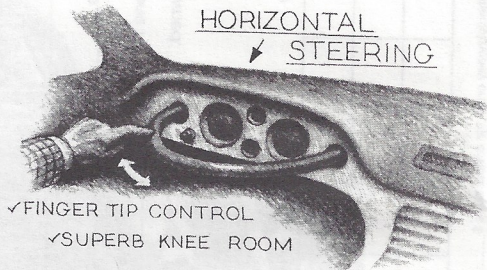

✓ FINGER TIP CONTROL
✓ SUPERB KNEE ROOM

SMART ACCELERATOR

ADJUSTS TO SHOE SIZE FOR ADDED SAFETY, COMFORT

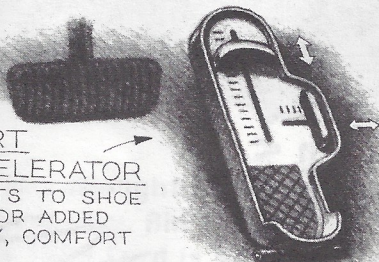

GRIDLOCK PERISCOPE

FIND OUT WHAT THE TIE-UP IS

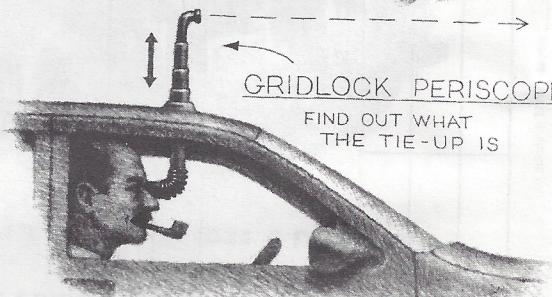

CEILING SHIFT

A WHOLE NEW FEEL!

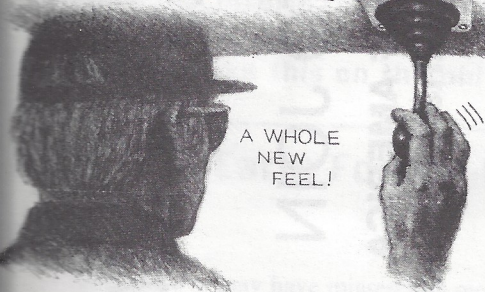

CONTINENTAL PARKING WHEEL

LOWERS AUTOMATICALLY TO SHOEHORN LARGE AUTO INTO TIGHT SPACE

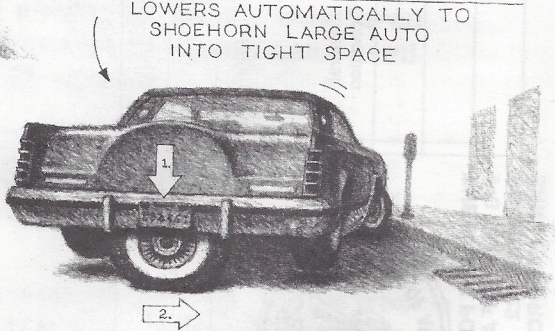

VIRTUAL GREASE MONKEY

ANIMATED MOTOR MONITOR REPLACES GAUGES, LIGHTS

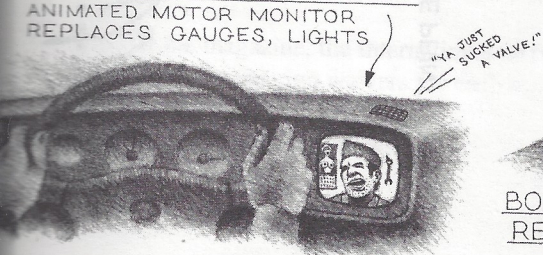

BOBBLE-HEAD REAR SAFETY LIGHT

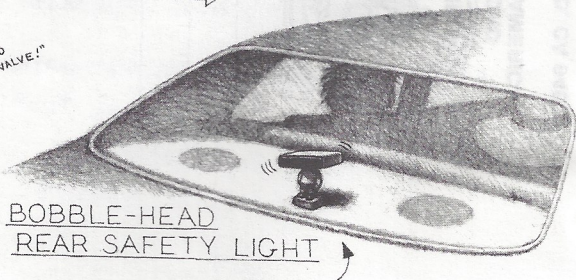



NOVEMBER V8 Birthdays



Nov. 3	Toni Mae Willie
Nov. 4	Richard Chutuk
Nov. 6	Ruth Spencer
Nov. 8	Steve Kawelmacher
Nov. 9	Joan Sapper
Nov. 9	Allen Franklin
Nov. 12	Ann Miles
Nov. 15	Mary Ruth Luening
Nov. 16	Ben DiFatta
Nov. 19	Robert Zecher
Nov. 20	Bill Boyer
Nov. 23	Don Coyle
Nov. 24	Jerry Chase
Nov. 25	Ernie Baily

We are saddened to learn of the death of Doug Peterson. Our Sympathy goes out to his family. Doug was a member of the Valley V8's for over 25 years, and president in 1972.

LAST A WHILE

1995 ANNUAL CHRISTMAS PARTY
SUNDAY, DECEMBER 3RD - 6:00 P.M.

THE SMOKE HOUSE RESTAURANT

4420 LAKESIDE DRIVE
BURBANK, CA. 91505

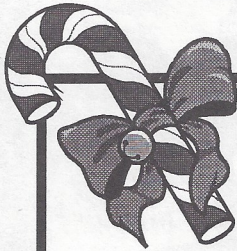

MENU SELECTIONS:

- >PRIME RIB OF BEEF
- >BROILED ORANGE ROUGHY
- >CHICKEN TERIYAKI SERVED OVER RICE

DINNERS SERVED WITH SALAD, VEGGIES,
POTATO/RICE, DESSERT & COFFEE OR TEA.

.....\$25.00 PER PERSON.....

ENCLOSE YOUR CHECK PAYABLE TO: VALLEY V-8 CLUB

NAME(S): _____

\$25.00 EACH PERSON...TOTAL ENCLOSED: \$ _____

ENTREE CHOICE(S):PRIME RIB _____ CHICKEN _____ FISH _____

SEND CHECKS TO: VALLEY V-8 CLUB
C/O LESLEY LITTNER

5051 BLACKPOOL AVENUE, AGOURA, CA. 91301 (818) 597-9016

RESERVATION CHECKS MUST BE RECEIVED BY: NOVEMBER 24TH !

DON'T MISS OUT! JOIN IN THE FUN.

Bring an unwrapped toy for a "Less Fortunate Child"
to the Valley V8's Christmas Party.

WELCOME NEW MEMBERS!

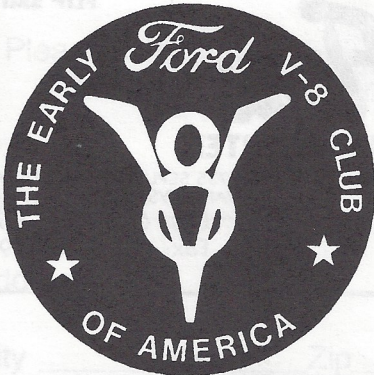

*Matthew Ettinger
1428 Airoso Road
La Habra Heights
(3) '37 Fords*

*Joe & Pam Arena
9812 Canby Avenue
Northridge
1950 Mercury*

Be sure to add them to your roster book!

CARS AND PARTS FOR SALE

1946 front end w/ steering col, spring, brakes, etc.
1941 V8 w/ trans complete, merc crank.
Allan Franklin (818) 842-2230

4 6:00x16 Goodyear (new) blackwalls & wheels.
John Wolf (818) 789-6201

1951 Ford Truck in primer. Lots of work done.
650x16 www tires, 3700 obo
Gary Walcher (619) 558-6228

CARS AND PARTS WANTED

1940-41 Ford pick-up gas fill neck.
John Wolf (818) 789-6201

Good C4 or C6 for small black Ford.
Mike Munroe (818) 789-7225

Cross bars for 1935 grill
Allan Franklin (818) 842-2230

SUPPORT OUR ADVERTISERS!

Chatsworth Auto Upholstery

Classics • Hot Rods • Foreign & Domestic

JIM ORTUNO
(818) 882-5161

21300 DEVONSHIRE ST.
CHATSWORTH, CA 91311

FLIP SMITH



7735 SEPULVEDA BOULEVARD
VAN NUYS, CALIFORNIA 91405

Bus: (818) 786-8686

Fax: (818) 785-2982

DON'S Auto Parts

MACHINE SHOP and BALANCING

Monday thru Friday 8 a.m. to 7 p.m.
Saturday 9 to 6 - Sunday 10 to 4

10241 Woodley (At Devonshire)

Domestic &
Foreign
Parts & Supplies



(818)

894-6441

Sepulveda, CA 91343

RAFFLE PRIZE DONOR

LESLEY A. LITTNER
(818) 597-9016 / FAX:597-9145

BOOKKEEPING & BUSINESS SERVICES

5051 BLACKPOOL AVE.
AGOURA, CA. 91301



Older Cars
A Specialty

4 x 4's and
Motorhomes

Russell Sylvis, Inc.

Transmissions
Repaired • Rebuilt

(805) 527-4387

4657 Barnard St.
Simi Valley, CA

R.C. Smith's Roofing Solutions

Roofing & Waterproofing • Complete Maintenance Service

8707-D Lindley Ave., Ste. 199, Northridge, CA 91325
Lic. #356650 (818) 718-2313

Auto • Homeowners

- ANTIQUE CARS -

ED HARDIN INSURANCE

Business • Life • Health • Aircraft



Call us for your Insurance needs!

(818) 363-7864

ALLAN FRANKLIN'S BATTERY TENDER

\$59.99

club members
\$54.99

Charges battery up and turns itself off
automatically when it fully charged.

Takes the guess work out of battery maintenance!

(818) 842-2230

6, 8, or 12 Volt Models

THE VALLEY V8's YOUR MEMBERSHIP IS EXPIRING

Please send your \$25.00 check for 1997 dues, payable to Valley V8's
(must be in no later than January 31st, 1997)

Name _____ Spouse _____

Address _____ Day Phone (_____) _____

City _____ State _____ Zip _____ Nite Phone (_____) _____

VEHICLE (S) OWNED (For directory, If same, write NO CHANGE.)

YEAR

MAKE

MODEL

BODY STYLE

NOTE: Local chapter members Must join the national Early Ford V8 Club
of America, P.O. Box 2122, San Leandro, CA 94577. \$32.00

Mail To:

**THE VALLEY V8 CLUB
C/O JERRY & LESLEY LITTNER
5051 BLACKPOOL AVENUE
AGOURA, CA 91301**

Burma-Shave

SUPPORT OUR ADVERTISERS!

L.T. "LEE" SAWYER, INC.

Jobber

Shell Oil and Chemical Products

14117 Aetna Street, Box 369
Van Nuys, California 91408

TOM SAWYER (818) 786-8180 / (818) 785-0902

RAFFLE PRIZE DONOR



**DiFATTA
GRAPHICS**
Incorporated

Joe DiFatta
Chief Executive Officer

27642 Avenue Hopkins
Valencia, California 91355

Phone: 805 295-8788
800 990-1939

Fax: 805 295-5069
Modem: 805 295-5119

CHEVY AND FORD TRUCKS • 4 x 4
55-56-57 CHEVY CARS 67-87 CAMARO 64-87 CHEVELLE
NEW AND USED PARTS

**American Auto & Truck
Dismantlers**

12172 Truman St. • San Fernando, CA 91340
(at Hubbard) **ROGER** (818) 365-3908

RESIDENTIAL • COMMERCIAL • INVESTMENT



Spencer Realty

5948 Goodland Ave.
Studio City, CA 91604
Office: 818-761-1734
Fax: 818-761-7952



AL SPENCER

QUALITY PROFESSIONAL SERVICE



John Mangiapane
(818) 994-5077

14743 Keswick Street
Van Nuys, CA 91405

Low prices
Repiping Specialist

Commercial & Residential
All Drain & Plumbing Needs

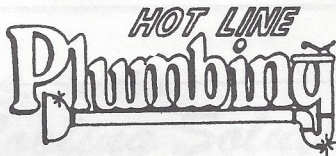

(818) 315-8601
State Contractors Lic. #682431

JED

New showroom salutes open road

After years of meticulous planning and development, California Car Cover Co. opened its new showroom for hundreds of automotive, truck and motorcycle parts and accessories.

The new gallery features distinctive settings for different products. Auto enthusiasts are invited to come and walk through the showroom to see the vast array of items offered by California Car Cover Co., such as car covers, car dusters, hardware, tools, clothing, and collectibles.

There's also a touch of the past, for enthusiasts. Classic automotive artifacts appear throughout the showroom, including vintage gas pumps, antique bicycles, and nostalgic signs. Company president Jim DeFrank spent years collecting these items.

The showroom is packed with hundreds of products that car, truck and motorcycle enthusiasts will find enticing. Everything from portable chairs to motorcycle covers is there.

The showroom is open to the public week days 8 a.m.-6 p.m. and Saturdays 9 a.m. to 3 p.m. For more information on California Car Cover Company or to receive a copy of the company's full-color catalog, call (800) 423-5525, or write to 9525 DeSoto Avenue, Chatsworth, CA 91311.

PAST PRESIDENTS

JIM ROWE.....	1971
DOUG PETERSON.....	1972
DON DURKEE.....	1974
ED WARNOCK.....	1975
JOHN BUSK.....	1976
CHIP WERSTEIN.....	1977
STAN MARSRAJE.....	1978
BOB DRAKE.....	1979
BILL CULP.....	1979
AL SPENCER.....	1980
LARRY CAPLAN.....	1981
BOB ROSE.....	1982
DON DURKEE.....	1983
PAUL KIRK.....	1984
KENT LOWRY.....	1985
DAVE SANBORN.....	1986
JOHN KEMMERER.....	1987
DUDLEY OCHSNER.....	1988
JERRY JENSEN.....	1989
JERRY JENSEN.....	1990
JOE DiFATTA.....	1991
CHUCK SHUBB.....	1992
CHUCK SHUBB.....	1993
GEORGE RICHARDS.....	1994
JERRY LITTNER.....	1995

Meetings are held on the first Sunday of every month at 7:00 p.m.

The Valley s

10532 GERALD AVE., GRANADA HILLS, CA 91325

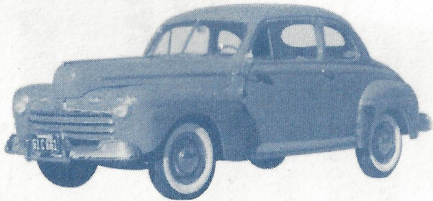
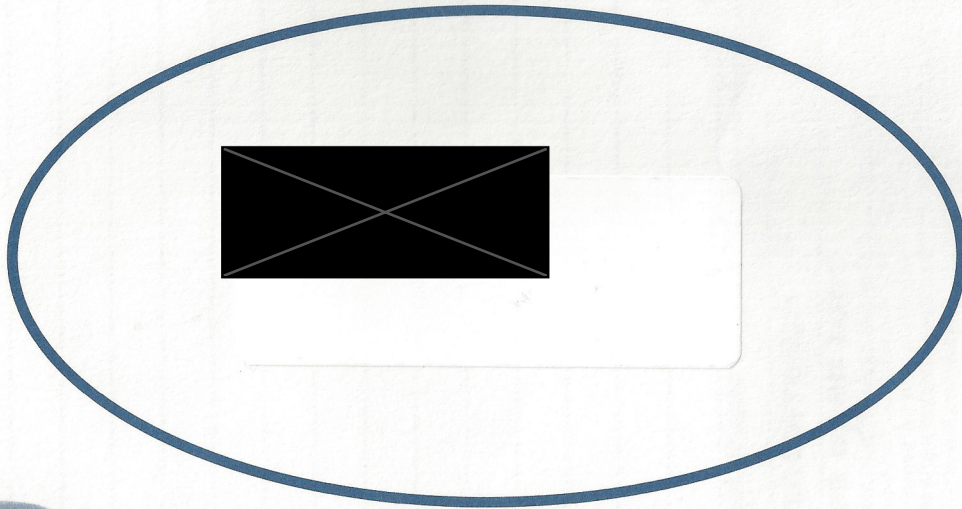

1946 Ford Coupe

