

Drive Lines

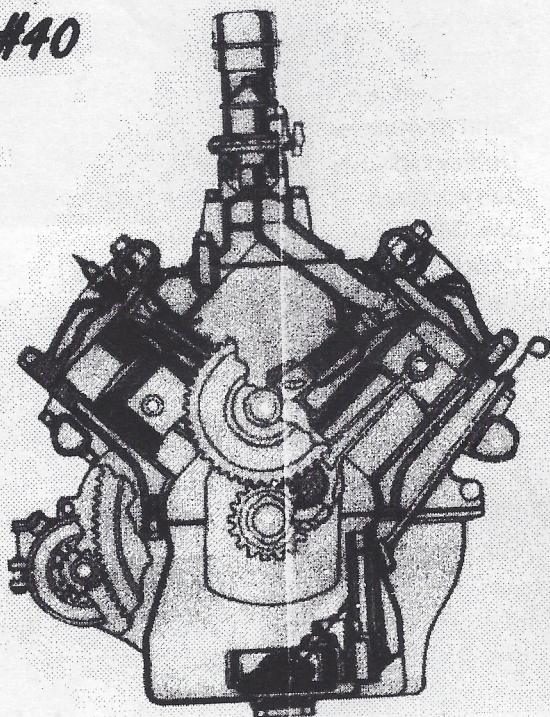

Our 39th Year

Chapter #40



March 2, 2010

Greetings Valley V8'ers,

Spring is in the air! Hope all of you enjoyed a special Valentine's Day with your sweetheart or special someone. When I arrived at Coco's last month it was awesome to round the corner of the dining room to find special Valentine's Day gifts and goodies so artfully displayed throughout the room.

Steve Lehman was working so hard to create that festive flavor for the holiday. Thanks Steve for your efforts on the raffle, as well.

After all of the usual meeting business, our guest speaker was Don Durkee. Don gave a very informative talk on auto body repair and brought along some of the tools associated with the job. He was joined by his two assistants Blaise and Tiffany who helped with the visual aids. Since Don knows his stuff, maybe I could persuade him to give me a hand's on auto body repair lesson. My '38 Ford has this one ding that could use some TLC. Now I know of someone I can call. Thanks, Don.

We rounded out the month February 21 with a field trip to the Reagan Presidential Library in Simi Valley.

It was an awesome turnout of over thirty of us. We met at Coco's Restaurant and made our way down the 118 freeway to the library. Since this was my first trip to the library, I was blown away with all of the artifacts on display at the museum. I have been to some museums in my day, but this one was exceptional. Our docent Bud filled our heads with a great deal of knowledge about Ronald and Nancy Reagan. Many of us spoke of how we could identify with this museum, as a good portion of the events happened at a time in our lives we could really remember. The icing on the cake was seeing the tail 27,000 Air Force One on display at the museum. As we entered the enormous Pavilion, I got goose-bumps actually being right up close to the plane. So close, you could almost touch it! Wow what an experience to take a photo outside the plane and then enter the exhibition that once flew with the former President.

After our tour was concluded, we all followed one another over to "The Hat" in Simi Valley. I can't think of a better way to end the day than with one of those mouth watering "World Famous Pastrami" sandwiches.

It was great to visit with everyone that was on the tour and share our thoughts of such a memorable day. Thanks to George and Shirley Richards for organizing the event.

Hope to see everyone at our March 2, 2010 meeting at Coco's restaurant. Our meeting will begin at 7:00pm. I will look forward to hearing our guest speaker that Dave Sanborn has scheduled.

See you at the meeting,

Dave

Subject: OVERDUE UPDATE ON BLACKY

HI ONE AND ALL,

IT'S TUESDAY FEB. 16 AND WE ARE ALMOST TO THE ONE YEAR MARK. HE STILL HAS NOT EATEN A MORSEL OF FOOD OR HAD ANYTHING TO DRINK. HE KEEPS TRYING THE "BOOGEE" (TUBE DOWN HIS THROAT). IT'S VERY DIFFICULT AND SOM ETIMES MAKES HIM COUGH THE REST OF THE DAY. WE ARE STILL GOING TO USC AT LEAST TWICE A WEEK FOR THERAPY. THEY ARE VERY ENCOURAGING AND BLACKY DOES NOT GIVE UP HOPE THAT HE WILL EAT AGAIN. HIS WEIGHT IS STAYING LEVEL AND HIS HAIR IS STILL CURLING! HE IS SPENDING LESS TIME ON THE COUCH AND MORE IN HIS BUILDING WORKING ON HIS 40 FORD PICKUP. LARRY CAPLAN AND DICK STONES WERE HERE LAST WEEK. WHAT A GOD SEND! HE HAS ALSO PLANTED HIS GARDEN ALTHOUGH THAT TOOK ALOT OUT OF HIM. DAUGHTER JULIE FELL 2 WEEKS AGO AND BROKE HER WRIST SO I HAD TWO PATIENTS BUT SHE'S MANAGING BETTER. THE MUCOUS IS STILL AN ISSUE AND BECAUSE OF THIS HE DOESN'T TALK MUCH. GIVES ME A CHANCE TO SPOUT OFF WITHOUT INTERRUPTION!!!!!! ALL IN ALL I MUST SAY I THINK HE'S GETTING BETTER BUT WE STILL HAVE A LONG WAY TO GO. ONCE AGAIN THANK YOU ALL FOR YOUR LOVE AND KINDNESS. WE LOVE HEARING FROM YOU. GOD BLESS OUR FRIENDS AND FAMILY. LOVE, GERRY

FOR SALE

1955 De Soto Project car \$5000.00 Call Steve 818-517 1268

**1965 Thunderbird Completely Restored Call Karen Lehman
\$15000.00 818-885-6938**

**1961 Buick Electra New Paint, and interior Plus recent Engine and
Trans. Overhaul --\$8500.00 Call Charlie Butler 805-985-7565.**

**1940 Ford Deluxe Tudor Sedan \$28000.00 OBO Call Jerry
818-632-9017**

Don Stout says--- That his garage is open the 1st Saturday of the month for coffee and kicks 22401 Itasca Ave. west of Shoup, between Lassen and Plumber, after 8:30 Oh! don;t look at the calender booby that's this Saturday!

CHICAGO RADIATOR SHOP:

"Best place in town to take a leak."

At the Electric Company

**"We would be delighted if you send in your
payment.**

However, if you don't, you will be."

In a Restaurant window:

" Don 't stand there and be hungry; come : in

Subj: **Feb. Min.**
 Date: 2/21/2010 11:38:41 A.M. Pacific Standard Time
 From: cal_Leo_karen@yahoo.com
 To: kellygrnflaty@aol.com

Secretary's Minutes

Date: Feb. 2, 2010

Meeting Place: CoCo's Woodland Hills

Meeting Leader: Dave Bergman

Start time: 7:05pm Adjournment time: 9:25pm

Introduction of guests: Blake Wilcox who has a '31 Woodie, '40 Ford convertible, '40 Chevy 2 dr. sedan, and a '28 Roadster pick-up. The Carters grandson Lucas.

Treasurer: Christine is not here tonight. Dave reports we are in the black.

Tours: The Laughlin tour is March 19 - 21. \$130 if we have 30 on the bus, and \$105 if we can get 40 people. Payment must be to Steve Boskovich by 2/12.

Announcements: Joe DiFatta read a card from Loaves and Fishes thanking us for the donation of toys that were collected at the Christmas party. The Fishes of West Valley also sent a thank you note. Dave Bergman read a letter from Arlene Bernholtz thanking all the club members who attended the service for Barry. She will not be renewing her membership at this time. Blackie update - He is undergoing therapy to open his throat. At this time he is being tube fed and has lost 45 lbs. Dennis had promised to sell a fan to Jim Kelley a while back, but could not find it. So he checked with Blackie to see if he had one. He did, but when Dennis offered to buy it for Jim, Blackie said no, I want you to give it to him. Randy Watson said that Gerry and Blackie want to put on a show at the Van Nuys airport in April for the club and then we would go to lunch at 94th Aero Squadron restaurant. Dave forwarded the new Board information to National. Not everyone has paid their dues. IT MUST BE PAID BY THE END OF THE MONTH. Aug.

8, 2011 is the official 40th anniversary of our chapter. Celebration plans are under development. Jim Kelly suggested we e-mail the Drive Lines to all who are willing. He passed around a sheet for e-mail addresses. This will save work and money. Helen Baker said our program for April will be Harrison Scott who will give a presentation on the Ridge Route. <http://www.ridgeroute.com/> At the end of the evening the club gave our waiter and waitress \$30 each for the great service we have received since coming to CoCo's.

Carl's car count: 6

Car of the month: Randy Watson '47 Super Deluxe Convertible

Drive prize [for bringing your V8 to the meeting]: Don Stout '40 Deluxe Coupe

Raffle winners:

Ladies: Shirley Richards and Virginia Wolf

Name badge: Craig Lapair

50/50 drawing: \$70 Joe DiFatta

Program for the evening: Don Durkee did a presentation on body work and his trip to Barrett-Jackson. He sold a coupe and delivered it to Tucson then went up to the Barrett-Jackson auction in Scottsdale <http://phoenix.about.com/cs/events/a/barrettjack01.htm> and Steel Dreamz In Gilbert.

<http://www.steeldreamz.com/aboutus.htm> Steel Dreamz has about two million dollars worth of muscle cars. He passed around brochures. He showed 4 spoons for dents, a pounding slapper and a monkey on a stick for trunks and hoods. He also had a bulls-eye for little dents. He brought an arc welder and talked about the difference between that and a tig/mig welder. <http://diy-welder.com/> {It's all Greek to me}

 Karen

Editors notes

Our speaker for the April is the author of the book on route 99 The Old Ridge Route. Several of our members have worked on the cleanup to persevere this area and this will be a good update on the whole project. This has always been a very entertaining evening and I myself can hardly wait.

If your riding ahead of the herd, it's a good thing to look back now and again to see if they are still following you or ifin your just off on your own again.

After eating an entire bull, a mountain lion felt so good that he started to roaring. He kept it up until a hunter came along and shot him. The Moral: If your full of bull keep your mouth shut.

Never slap a man chewing tobacco.

It don't take a genius to spot a goat in a flock of sheep.

I was thinking about how a status symbol of today is those cell phones that everyone seem to have clipped to onto their belt or purse. I can't afford one . So I'm wearing my garage door opener. I also made a cover for my hearing aid and now I have what they call blue teeth. I think.

I think it would get more results if they put the pictures of missing husbands on beer cans

I deeply involved in a new exercise program for us older folks I'm going to call it PUMPING RUST.

When people see the cats litter box they say Oh! do you have a cat? Just once I would like to say OH! No the dumb toilet is stopped up again.

In life you should remember : It is not how many breathes you take: but rather how many fantastic experiences you have that take your breath away.

How can illiterate people get enjoyment out of Alphabet Soup?

Don't take yourself to seriously . No one else does

Answer:

Devonshire Street was the designated State Route 118.

2010 CALENDAR

*March 19-21- Laughlin Trip

April 25- Fabulous Fords at Knott's Berry Farm

*April-May- Malibu Paradise Cove Breakfast TBD

June 20 -L.A. Roadsters Show & Swap Meet at the Pomona Fairplex

June 23-26 - Eastern National Meet -- TO CAROLINA AGAIN IN 2010 Charlotte-Concord, North Carolina

*July- Annual Club BBQ TBD

*Sept-October Club Auction TBD

October 18-20 Western Nat'l Meet FRIENDS & FORDS, 2010, ST. GEORGE UTAH

*December 5- Holiday Party

Ongoing events

Bob's Big Boy - Every Friday night at Toluca Lake and Northridge

Van Nuys Blvd. Cruise Nite 2nd Wednesday of every month- Rain or shine

*Denotes club event

Don Stout says--- That his garage is open the 1st Saturday of the month for coffee and kicks 22401 Itasca Ave. west of Shoup, between Lassen and Plumber, after 8:30 That's this Saturday!

I'm here for some Kixs ! Sunny

The valley trivia fun question for the drive lines is as follows.

What street in the San Fernando Valley was designated state highway 118 before completion of the Simi Valley Freeway? (Answer: elsewhere in Drive Lines)

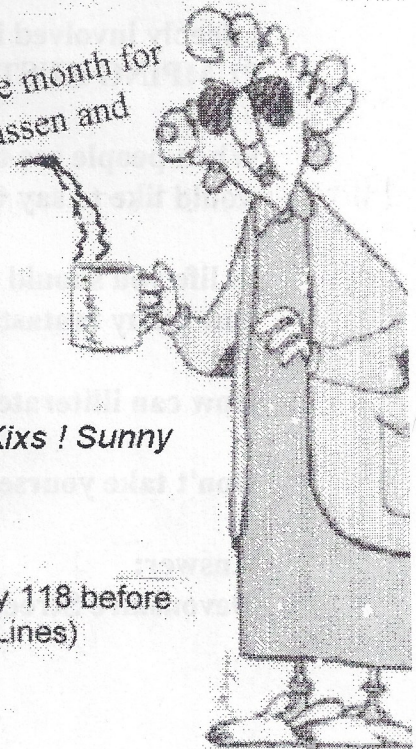

Our speaker for the March 2010 meeting is

Jimmy Weldon

Jimmy is an 80+ years young Motivator

His Presentation will be

Go Get 'em Tiger

Jimmy's clients include:

AT&T
Boeing
Farmers Insurance
Century 21

Hi television and movies include:

Dragnet
Dallas
Knight Rider
Waltons
The Flintstones
Chattanooga Choo Choo

For an *entertaining, enjoyable evening* come to the March meeting

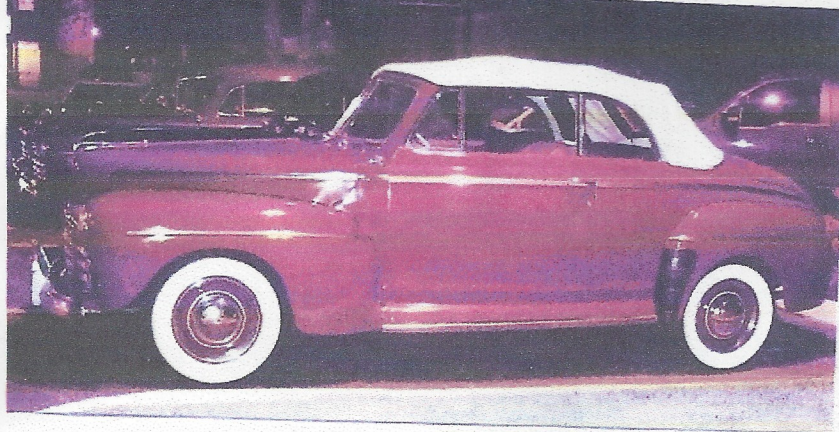
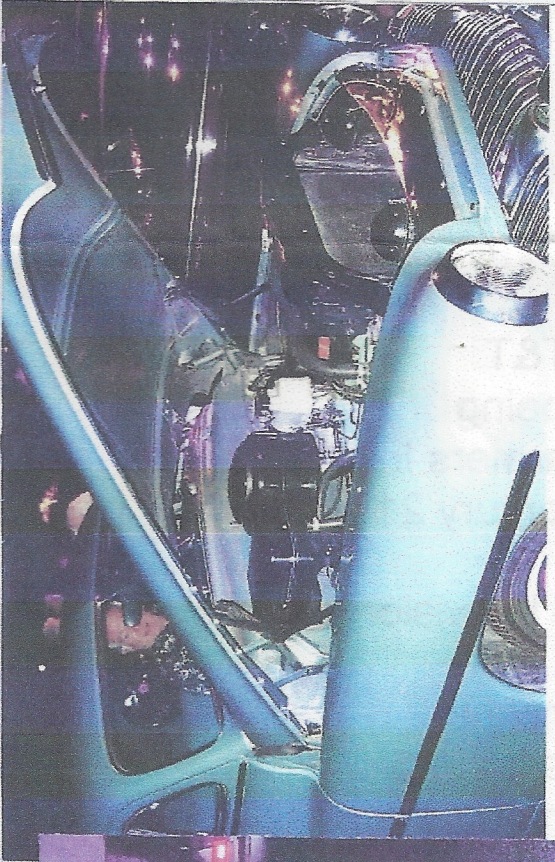
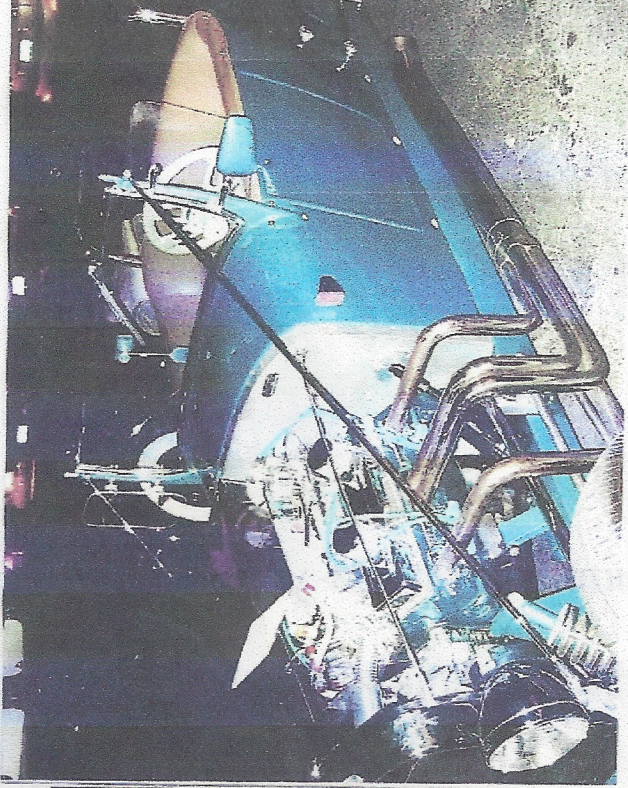

APRIL 17, 2010

AN EXTRAORDINARY OPPORTUNITY
TO VISIT 2 VERY SPECIAL
L.A. CITY FIRE STATIONS.

STATION 114
AIR OPERATIONS
&
FIRE STATION 90
BOTH LOCATED AT VAN NUYS AIRPORT

STATION 114 HOUSES THE DEPT. HELICOPTERS
& CRASH & RESCUE UNITS
STATION 90 HANDLES ALL OTHER OPERATIONS
AT THE VAN NUYS AIRPORT

LEAVE - WOODLEY PARK AT
8:30 AM Woodley at Victory
AFTER THE TOURS
LUNCH AT
THE 94TH AERO SQUADRON
RESTAURANT

LAUGHLIN WEEKEND TRIP

MARCH 19-21

JOIN YOUR FRIENDS ON A BUS TRIP
TO LAUGHLIN FOR A WEEKEND OF
FUN, SUN, FOOD AND DRINK
AS WELL AS ENTERTAINMENT AND
GAMBLING

\$130.00 PER PERSON INCLUDES
TRANSPORTATION, HOTEL
ACCOMODATIONS FOR 2 NIGHTS, 1
BREAKFAST BUFFET

THERE WILL BE BINGO ON THE BUS
GOING AND MOVIES ON THE WAY
HOME

LEAVE CHATSWORTH @10:00a.m. on
Friday, Return at 4:00p.m. on Sunday
See Steve Boskovich for more info
818-34-6876

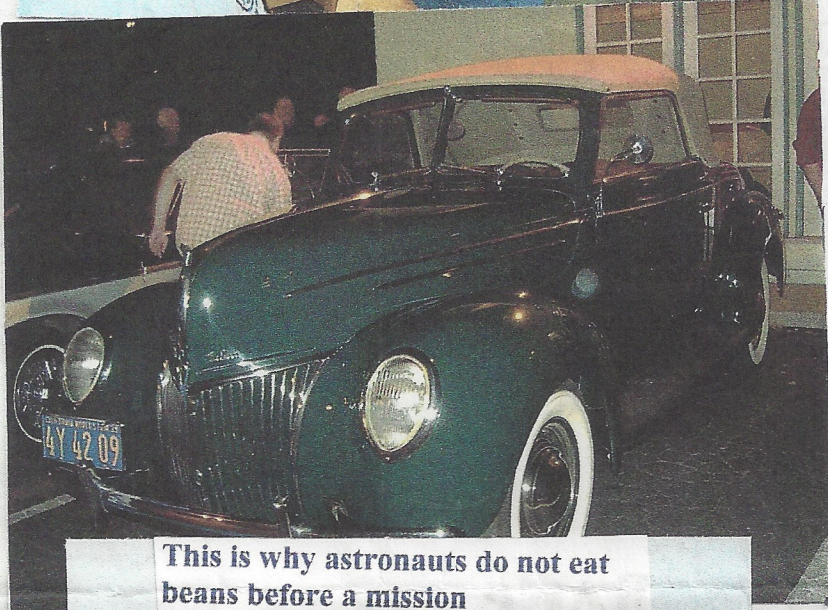

This is why astronauts do not eat beans before a mission

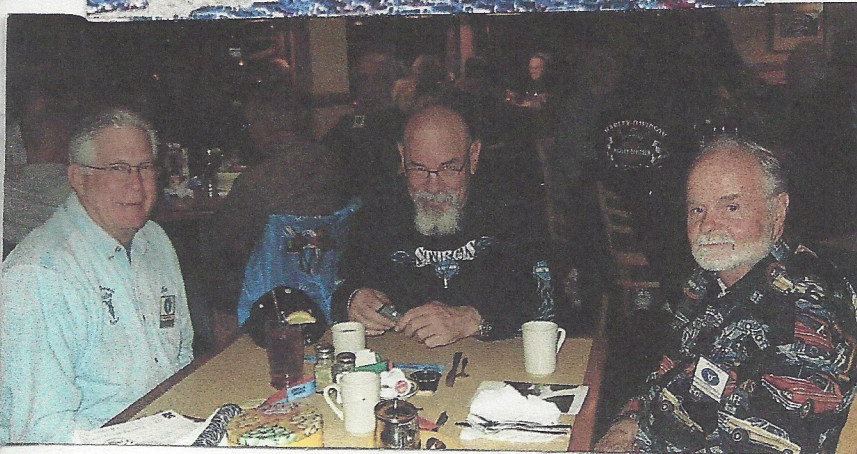

The Valley 's

2009 Officers

President	Dave Bergman	(818) 703-0756
Past President	Harry Baker	(818) -705-3930
Vice President	Randy Watson	(805)-496-2430
Secretary	Karen Lehman	(818) 885-6938
Treasurer	Christine Varney	(818) 709-0741
Tours	George Richards	(818)-992-4537
Programs	Don Durkæe - Joe Di Fatta	
Drive Lines	Jim Kelley	(310) 823-6020
Membership	Dick Stones	(805) 230-0070
Prize Raffle	Steve Lehman	(818)-885-6938 ;
50 /50 Raffle	Don Stout	(818) 998-7054
Mrs. Sunshine	Virginia Wolf	(818) 789-6201
Ladies Raffle	Joan Sapper	(818)-249-5686
Web Master	Scott Doudrick	(818) 957-5708
Car Count	Carl Batesole	
Car of the Month	Jerry Jensen	(805) 491-3355

Meeting: 1st Tuesday of the month 7:00 PM.

No host dinner starting at 6:00 PM.

Coco's Restaurant

22200 Sherman Way, West Hills, CA.

2 blocks west of Topanga Canyon Blvd.

Drive Lines is Published by
The San Fernando Valley, Regional Group 40
of the Early Ford V-8 Club of America
7822 West 79Th Street
Playa Del Rey, Ca. 90293

The Valley 's

PAST PRESIDENTS

Jim Rowe	1971
Doug Peterson	1972
Don Durkee	1973 - 1974
Ed Warnock	1975
John Busk	1976
Chip Werstein	1977
Stan Misraje	1978
Bill Culp	1979
Al Spencer	1980
Larry Caplan	1981
Bob Rose	1982
Don Durkee	1983
Paul Kirk	1984
Kent Lowry	1985
Dave Sanborn	1986
John Kemmerer	1987
Dudley Ochsner	1988
Jerry Jensen	1989 - 1990
Joe DiFatta	1991
Chuck Shubb	1992 - 1993
George Richards	1994
Jerry Littner	1995
Dick Smith	1996
Chuck Mair	1997
Dennis Keene	1998
Rose Gott	1999
Don Stout	2000
Steve Boskovich	2001 - 2002
Joe DiFatta	2003
Wendi Potter	2004
Ken Sapper	2005 - 2006
Steve Batesole	2007
Harry Baker	2008 - 2009

The Valley 's

7822 West 79 Th Street Playa Del Rey, CA 90293

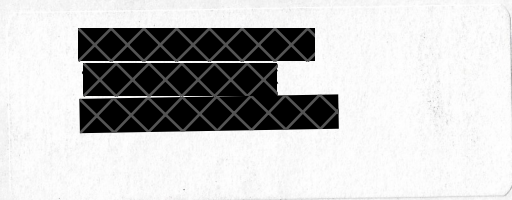

9132689049 0013

